

# SHORT TREE PRODUCTS

5TH EDITION MOULDINGS CATALOG

FULL-LINE

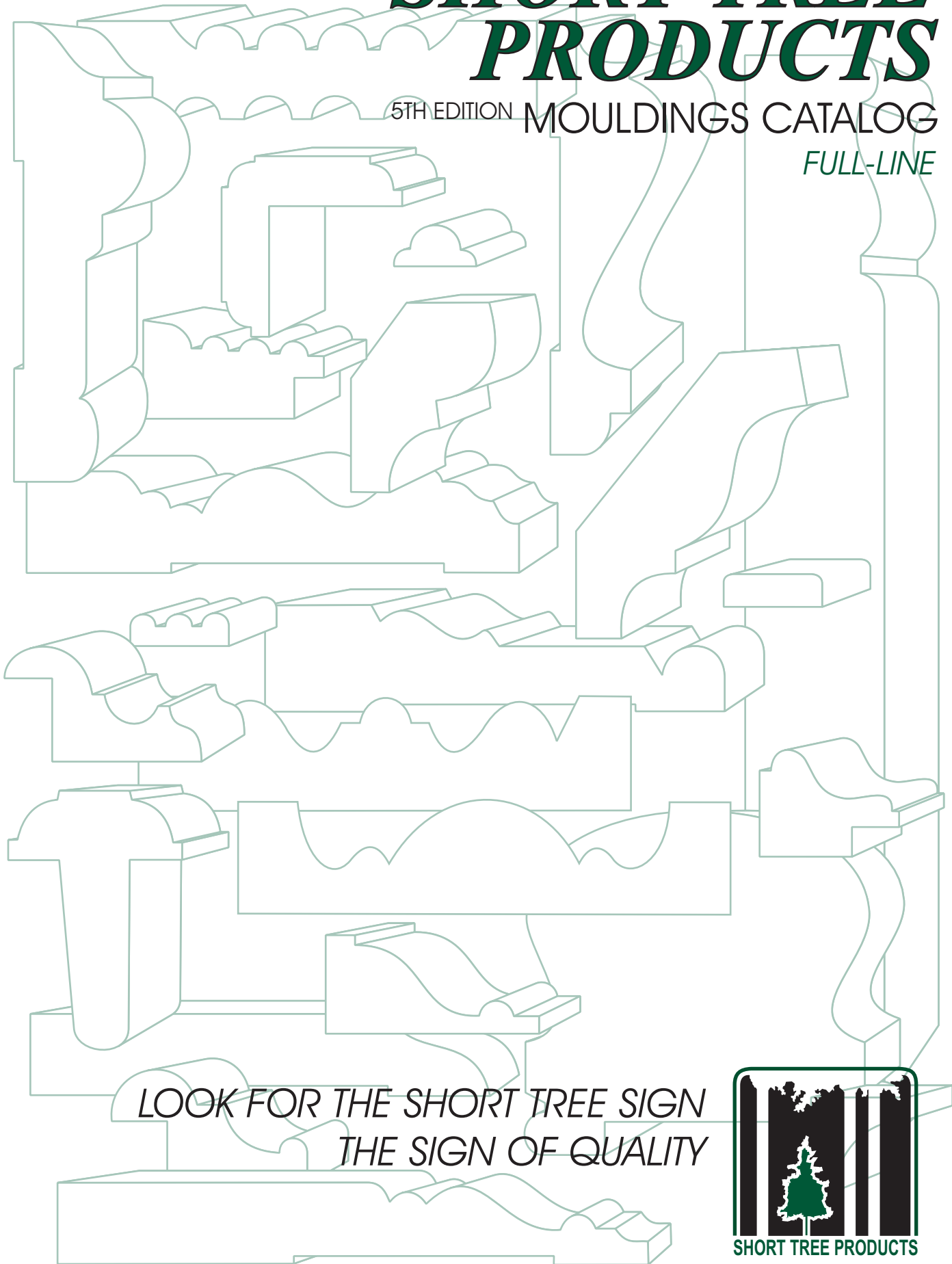

LOOK FOR THE SHORT TREE SIGN  
THE SIGN OF QUALITY



*SHORT TREE PRODUCTS is proud to present our 4th edition of our full-line mouldings catalog. We are a manufacturer of fine wood mouldings known throughout the area. We have on stock approximately 400,000 lineal feet of stock mouldings as well as hundreds of thousands of board feet of raw materials to produce over two million lineal feet of moulding each year. Many of these moulding profiles may be combined to produce various combinations of base chair rails and cornices, the combinations are endless.*

*Visit us on the Web  
[www.shorttreeproducts.com](http://www.shorttreeproducts.com)*



*Always Ask For Genuine Short Tree Products*



## QUALITY STANDARDS

1. *Natural grain variations, such as cats eye, birds eye, burl, curly or cross grain are not considered defects in any grade.*
2. *Checks or splits not exceeding 1/32" x 3" are acceptable on moldings and s4s products.*
3. *Sapwood is not considered a defect.*
4. *Pin knots and worm holes less than 3/16" in diameter are acceptable.*
5. *SHORT TREE can not guarantee uniformity of color due to the natural color or graining of the wood itself.*
6. *Slight discoloration from mineral stain - streaks and spots are acceptable.*
7. *In order to secure the best performing material in hardwoods and softwoods gluing for width is permitted at our option.*
8. *Due to tensions of the grain and or imperfections of the piece, SHORT TREE can not guarantee the straightness or flatness of each piece*

## CUSTOM MOULDS

*SHORT TREE PRODUCTS can produce that custom mould to your detail or sample from as little as a few feet to thousands of feet. Our large library of knives and the ability to do in house grinding allows us to match that custom mould you need in a variety of species and lengths depending on availability. Specified lengths are possible depending on our inventory and or availability of material needed.*

## RADIUS MOULDS

*Any of these stock moulds as well as custom moulds can be made on virtually any radius. Ask your salesperson for a quote.*

## GENUINE SHORT TREE PRODUCTS

*Please consult your salesperson, at your local lumber yard or home center, for all your short tree products needs.*



## STORAGE AND JOB CONDITIONS

1. *Store woodwork in a clean, dry well ventilated area.*
2. *Protect from weather, dirt and damage.*
3. *When storing millwork and mouldings for extended periods of time or in areas of higher than recommended humidity, seal all pieces as soon as possible.*
4. *Millwork shall be handled with clean dry hands or while wearing clean gloves.*
5. *Millwork shall be lifted and carried not dragged or pushed.*
6. *Millwork shall not be exposed to excessive moisture, heat, cold, dryness and direct sunlight as well as excessive air flow.*
7. *Purchaser must realize any part of a cabinet or millwork can expand or contract due to the nature of wood itself in either dryness or humidity.*
8. *Millwork must be allowed to acclimate to installation area conditions prior to installation.*

## CAUTION WOOD DUST

*Sawing, sanding, or machining wood products can produce wood dust which can cause a flammable or explosive hazard.*

*Wood dust may cause lung, and upper respiratory tract, eye and skin irritation. Some wood species may cause dermatitis and / or respiratory allergic effects.*

- \* *AVOID DUST CONTACT WITH IGNITION.*
- \* *SWEEP OR VACUUM DUST FOR RECOVERY OR DISPOSAL.*
- \* *AVOID PROLONGED OR REPEATED BREATHING OF WOOD DUST.*
- \* *AVOID DUST CONTACT WITH EYES AND SKIN.*

*FIRST AID : If inhaled, move to fresh air. In case of contact, flush eyes and skin with water. If irritation persists call a physician.*

<b>CONTENTS</b>	<b>PAGE #</b>
INTRODUCTION .....	2-6
APRONS .....	12-14
BACKBANDS .....	15
BAND MOULD .....	30
BAR RAIL .....	52
BASE .....	16-19
BASE CAP .....	20,21
BASE SHOE .....	19
BASE MOULD .....	29
BED & COVE .....	35,36
BRICK MOULD .....	43
CAP & SHOE .....	33
CASING .....	7-14
CEILING & PARTITION .....	58
CHAIR RAIL .....	22-25
CHAIR RAIL CAP .....	25
CORNER MOULD .....	44
CROWN .....	37-40
DENTIL MOULD .....	41,42
FLOORING .....	61
GLASS BEAD .....	31
HALF ROUND .....	32
HAND RAIL .....	49-52
LANDING TREAD .....	33
LATTICE .....	33
MIRROR MOULD .....	44
NOSE & COVE .....	34
PANELING .....	55-57
PANEL MOULD .....	27-30
PICTURE FRAME .....	26
PICTURE MOULD .....	26
PLYNTH BLOCK .....	46
QUARTER ROUND .....	32
RADIUS & ARCH TRIM .....	48
ROSETTES .....	47
S4S/SQUARES .....	53
SCREEN MOULD .....	31
SHELF CLEATS .....	44
SIDING .....	59-61
STOP.....	43
T-ASTRAGAL .....	43
THRESHOLD .....	44
WAINSCOTING .....	54
WINDOW STOOLS .....	45
INDEX.....	62,63

*All profiles in this catalog were drawn full size, though size may have changed due to reproduction of this catalog*



# CORNICES

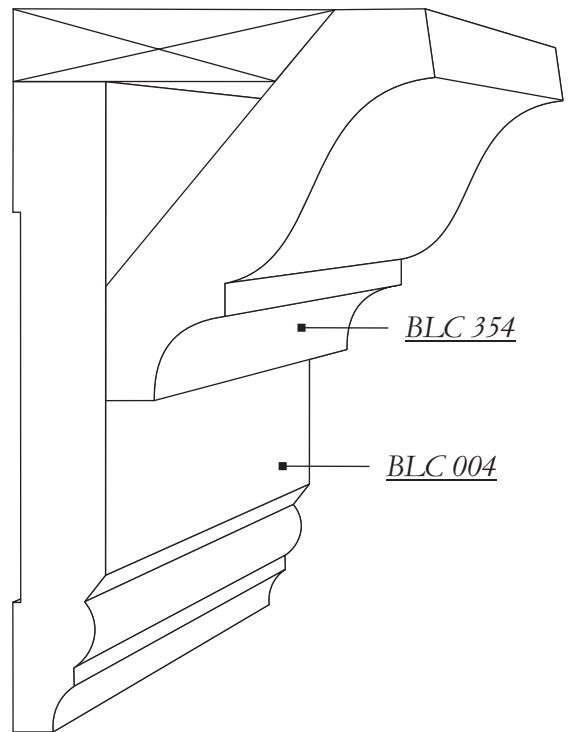
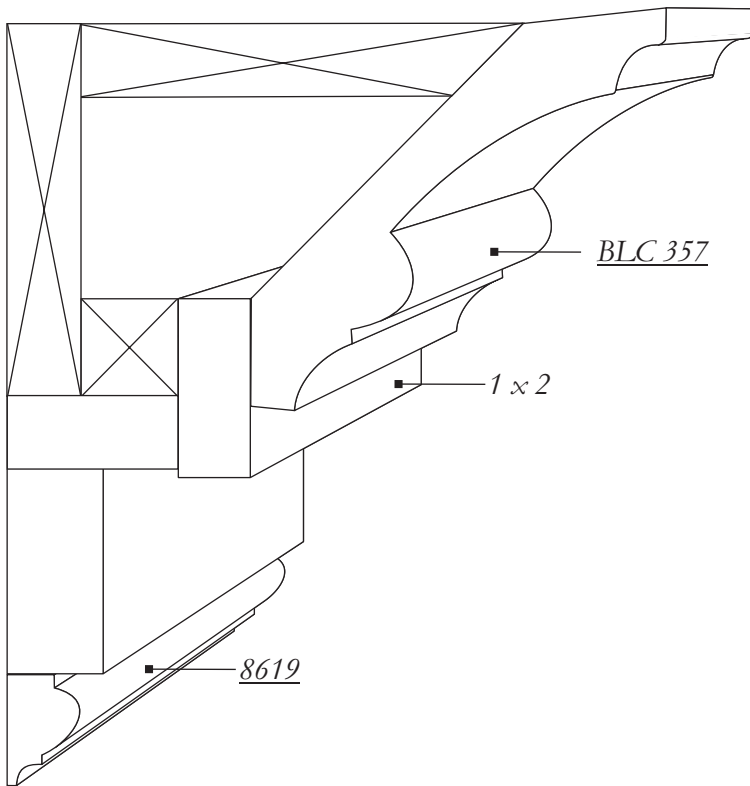
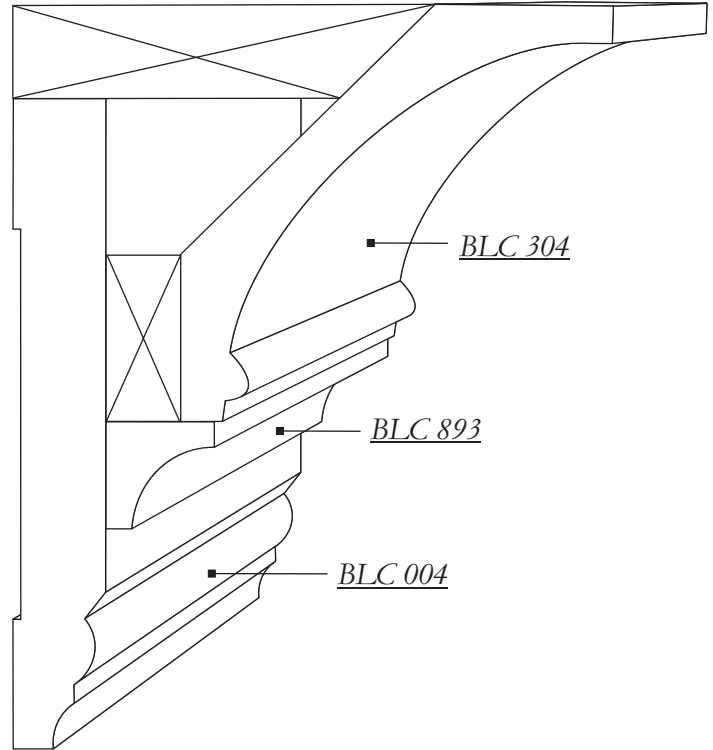
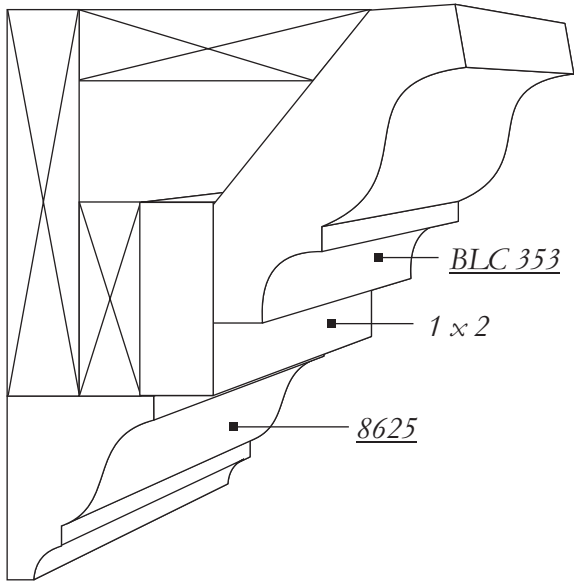

*Cornices reduced from full size*



# CASING

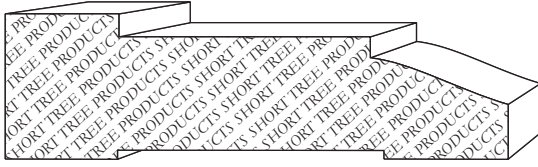

BLC 102 3/4" x 2 5/8"

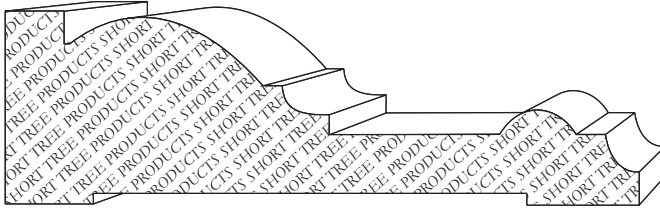

G-12 1" x 3 5/16"

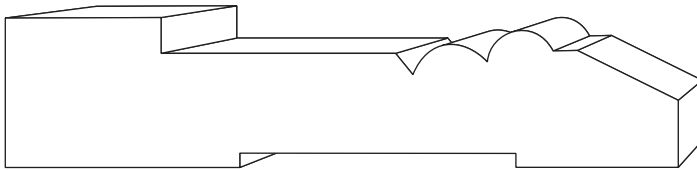

BLC 114 3/4" x 3 1/2"

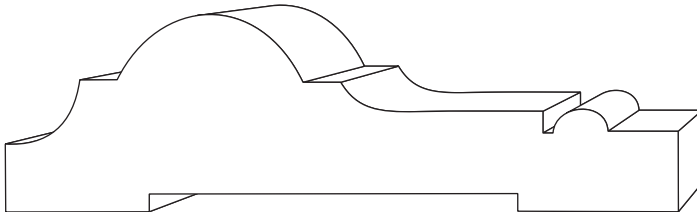

BLC 130 1" x 3 1/2"

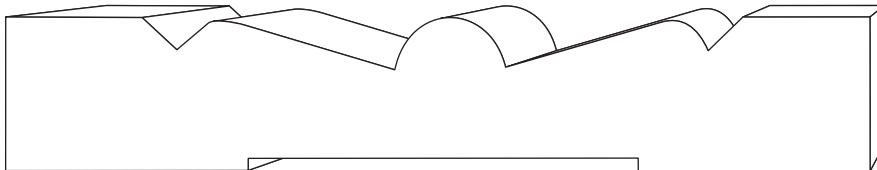

BLC 131 13/16" x 4 1/2"

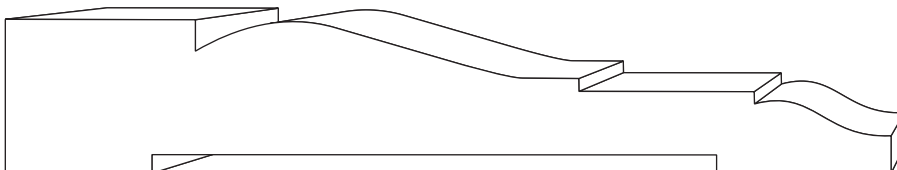

Exp 361 3/4" x 4 5/8"

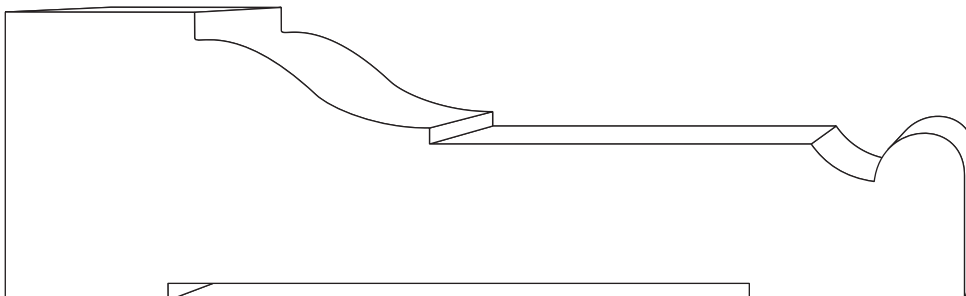

BLC 111 1 1/2" x 5"



Ⓢ STOCKED OAK, POPLAR ONLY \*STOCKED OAK, POPLAR AND PINE

# CASING

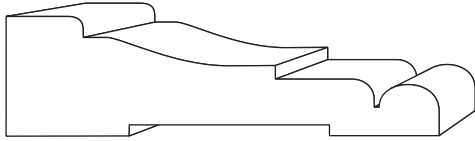

BLC 127 5/8" x 2 1/4"

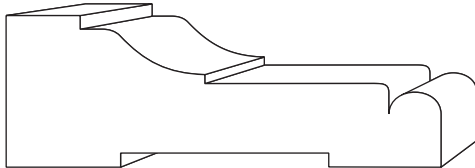

BLC 126 3/4" x 2 1/4"

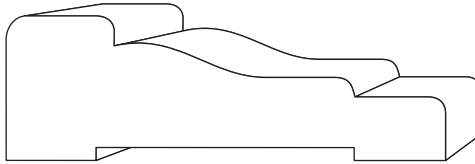

BLC 129 3/4" x 2 1/4"

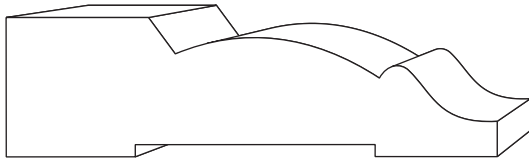

C-13 3/4" x 2 1/2"

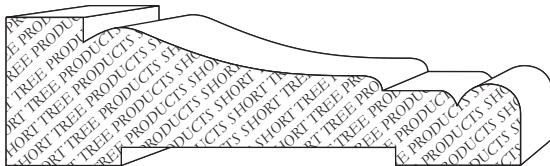

BLC 108 3/4" x 2 5/8"

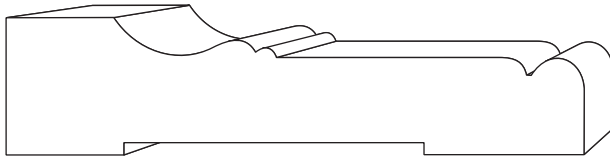

BLC 107 3/4" x 3"

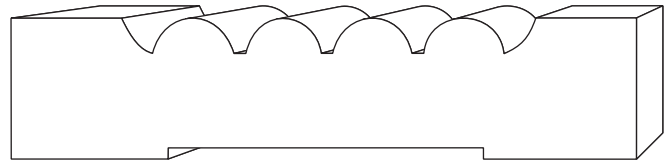

BLC 109 3/4" x 3 1/4"

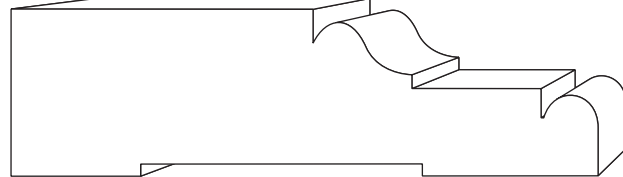

BLC 125 7/8" x 3"

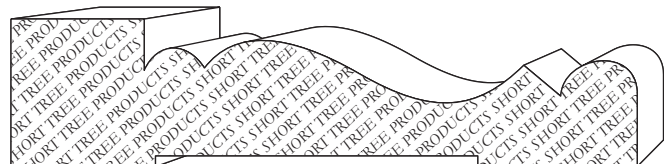

BLC 113 3/4" x 3 1/4"

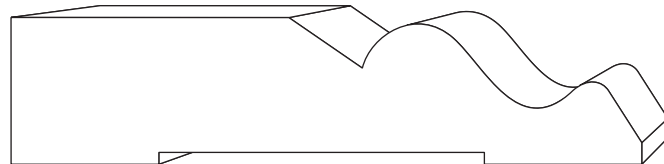

BLC 1111 3/4" x 3 1/4"

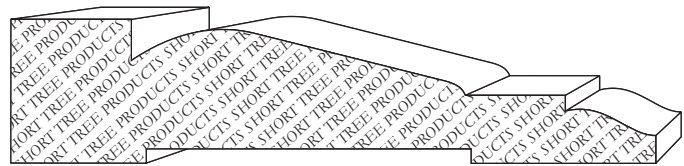

\*Exp. 361 11/16" x 3 3/8"



BLC 133 3/4" x 3 1/2"

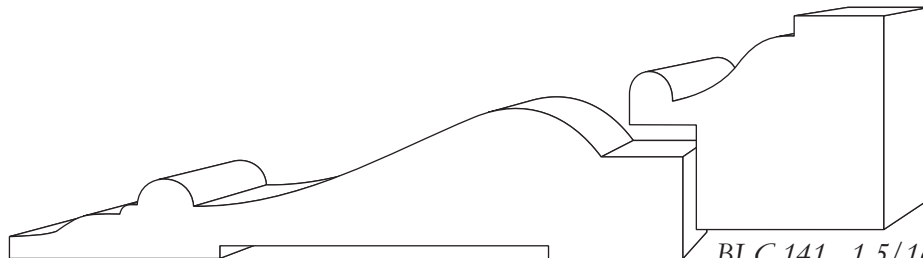

BLC 140 3/4" x 3 1/2"

BLC 141 1 5/16" x 1 1/8"





# CASING

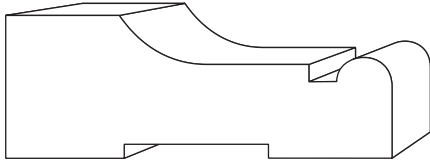

BLC 112 3/4" x 2"

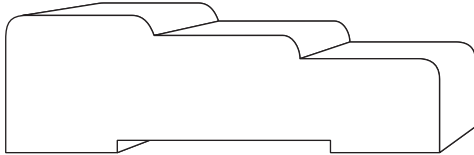

WP 385 3/4" x 2 1/4"

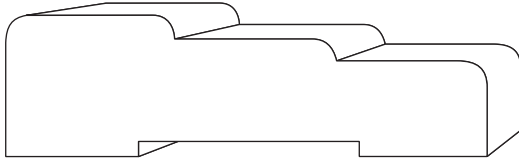

WP 380 3/4" x 2 1/2"

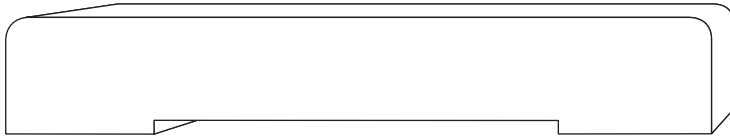

8640 5/8" x 3 5/8"

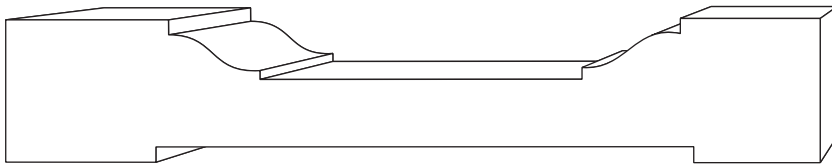

8289 3/4" x 4 1/4"

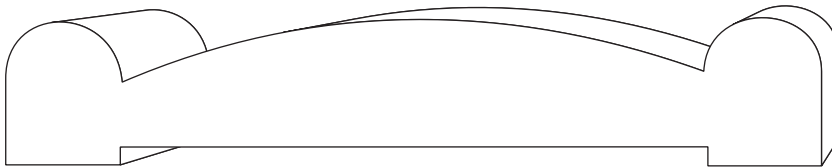

8341 3/4" x 4 1/4"

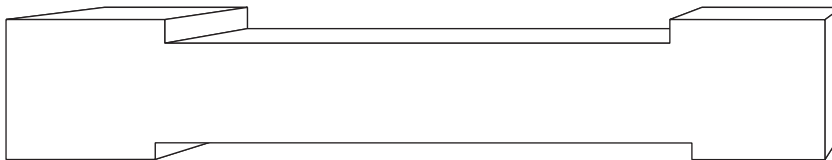

8706 3/4" x 4 1/4"



Ⓢ STOCKED OAK, POPLAR ONLY \*STOCKED OAK, POPLAR AND PINE

# CASING

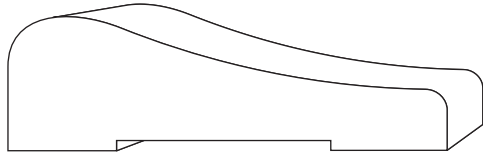

WP 320 3/4" x 2 1/4"

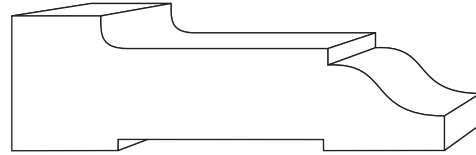

WP 345 3/4" x 2 1/4"

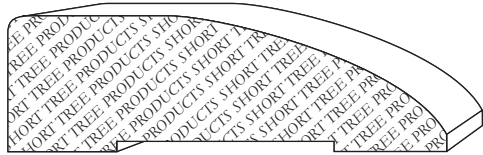

BLC 105 3/4" x 2 1/4"

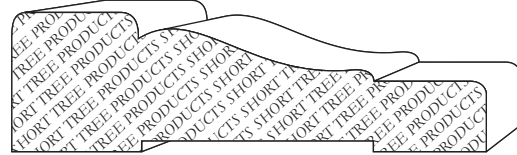

BLC 103 3/4" x 2 1/2"

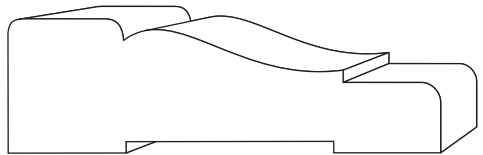

WP 355 3/4" x 2 1/4"

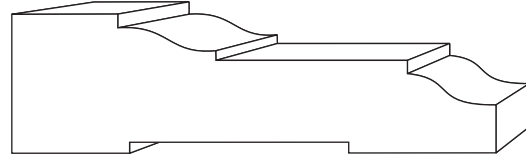

WP 330 3/4" x 2 1/2"

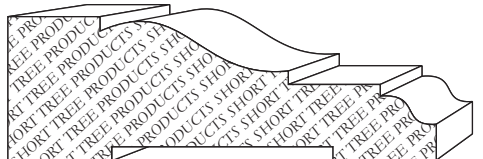

WP 365 3/4" x 2 1/4"

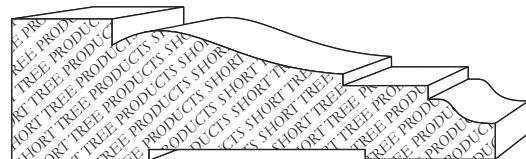

BLC 104 3/4" x 2 1/2"

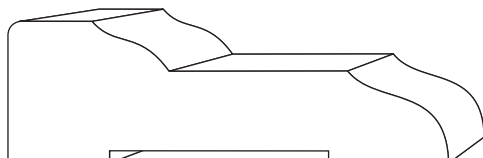

WP 335 3/4" x 2 1/4"

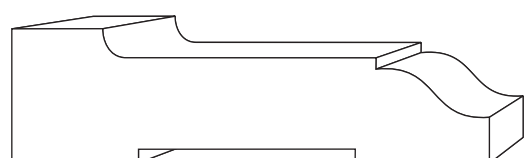

WP 340 3/4" x 2 1/2"

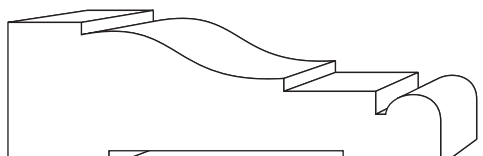

WP 375 3/4" x 2 1/4"

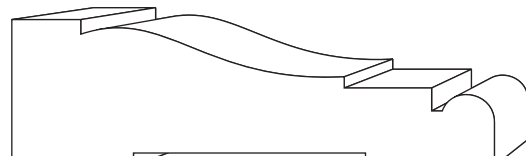

WP 370 3/4" x 2 1/2"



# CASING

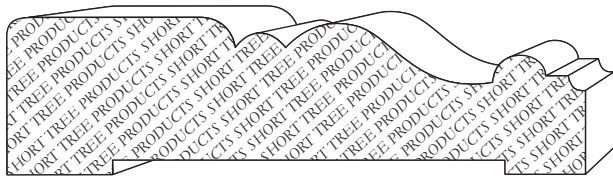

BLCCA-300 13/16" x 3"

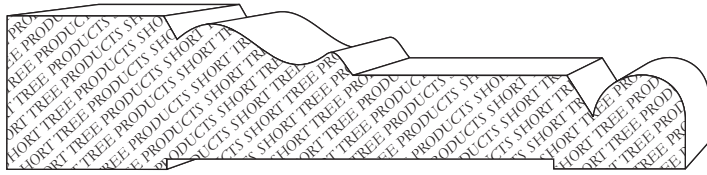

BLCCA-360 13/16" x 3 1/2"

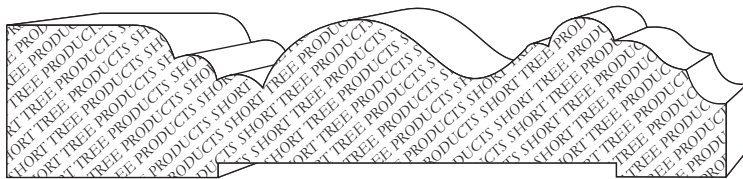

BLCCA-301 13/16" x 3 3/4"

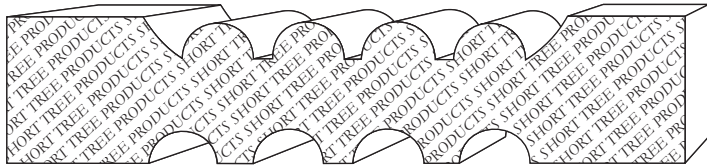

BLC 135 3/4" x 3 1/2"



BLC 136 3/4" x 4"



# CASING & APRONS

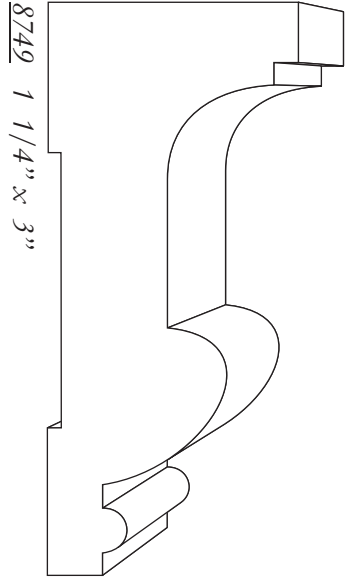

8749 1 1/4" x 3"

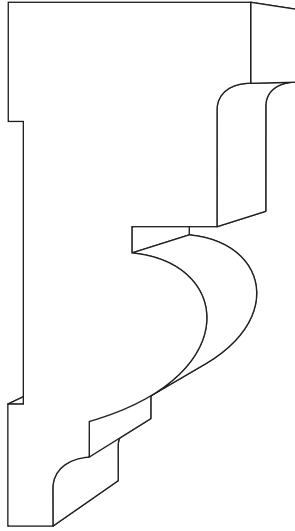

8748 1 1/4" x 2 3/4"

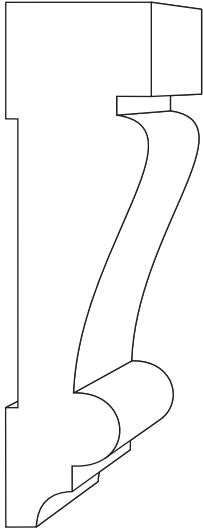

8750 3/4" x 2 3/4"

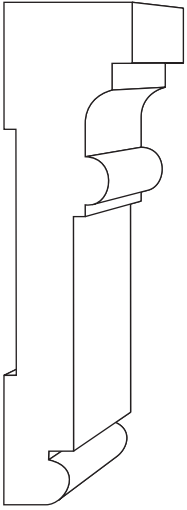

8742 3/4" x 2 5/8"

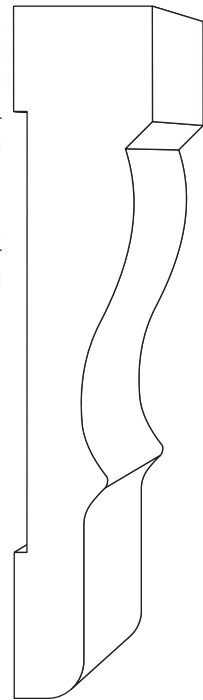

8754 3/4" x 3 5/8"

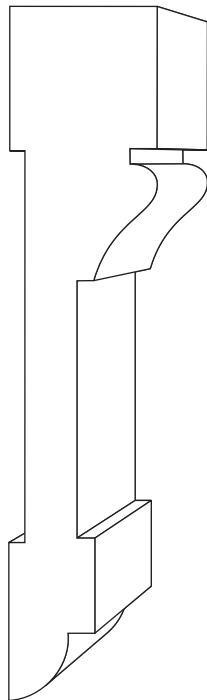

8747 3/4" x 3 5/8"

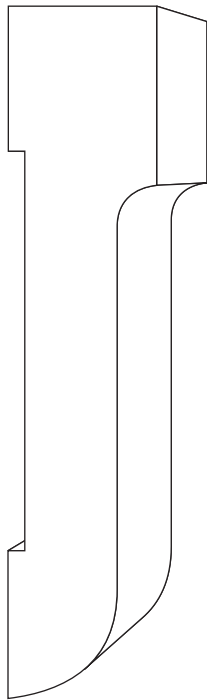

8743 3/4" x 3 5/8"

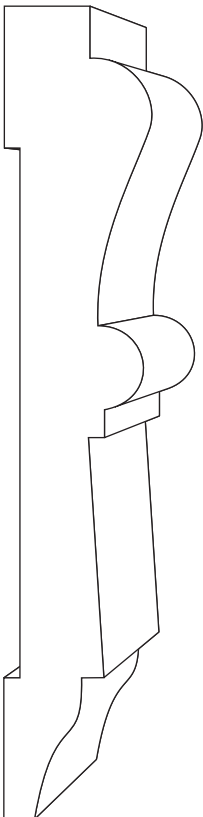

8752 3/4" x 4 1/4"

# CASING & APRONS

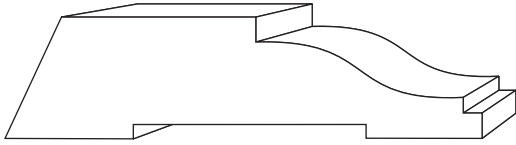

8635 5/8" x 2 1/2"

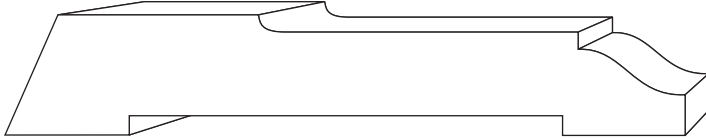

8636 5/8" x 3 1/2"

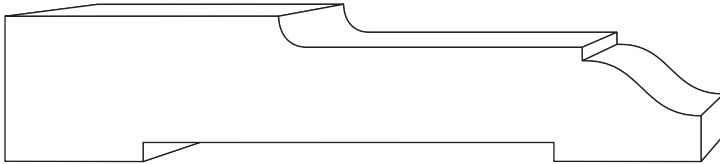

8711 3/4" x 3 5/8"

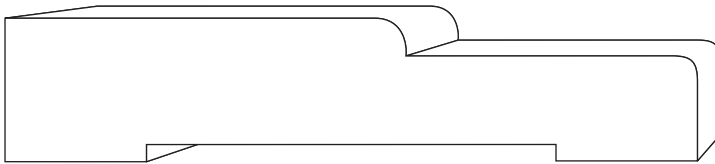

8358 3/4" x 3 5/8"

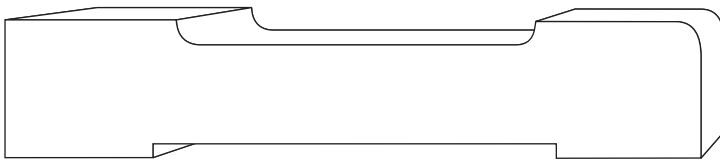

8755 3/4" x 3 5/8"



8712 3/4" x 3 5/8"



Ⓢ STOCKED OAK, POPLAR ONLY \*STOCKED OAK, POPLAR AND PINE

# CASING & APRONS

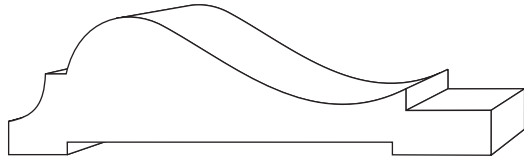

8843 3/4" x 2 1/2"

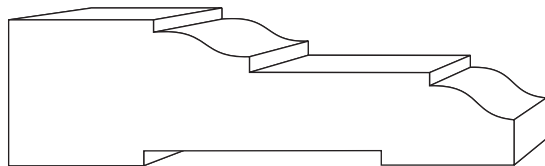

8845 3/4" x 2 5/8"

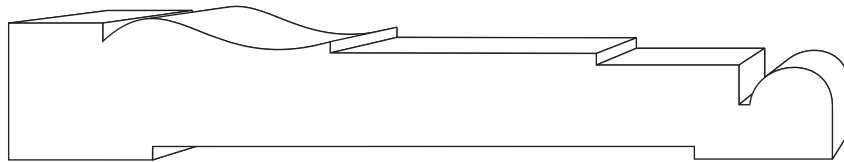

8644 3/4" x 4 1/4"

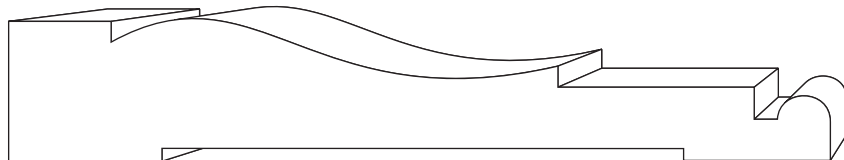

DC 100 3/4" x 4 1/4"

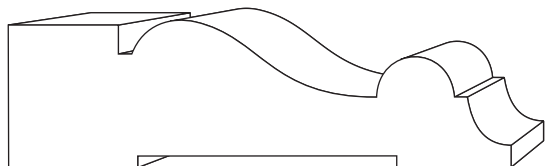

DC 12 3/4" x 2 5/8"

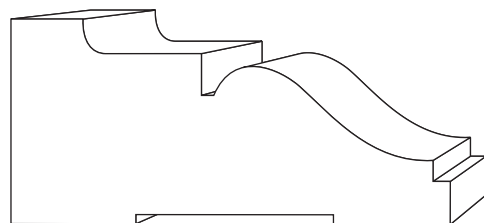

DC 81 1 1/16" x 2 1/4"

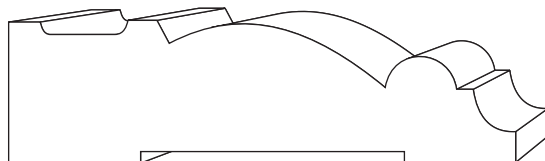

DC 67 3/4" x 2 5/8"

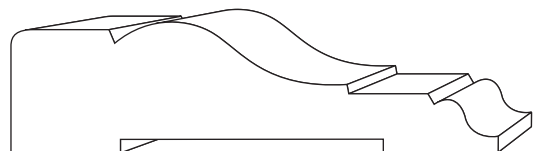

NY 100 11/16" x 2 1/2"

# BACK BANDS

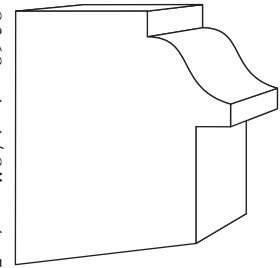

8368 1 1/8" x 1 5/16"

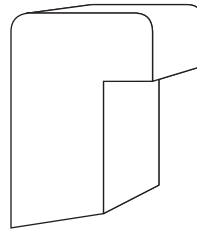

8313 3/4" x 1 1/8"

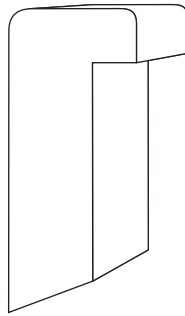

NY 110 11/16" x 1 5/8"

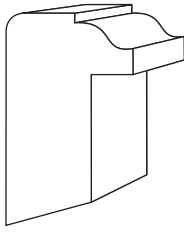

NY 112 11/16" x 1 1/8"

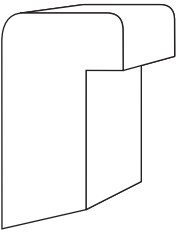

NY 111 11/16" x 1 1/8"

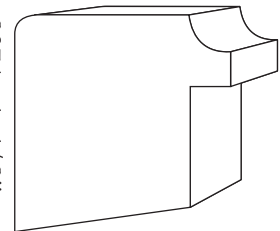

8374 1 1/8" x 1 1/8"

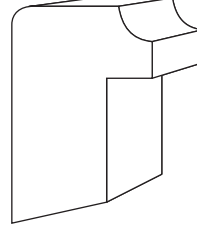

8317 3/4" x 1 1/8"

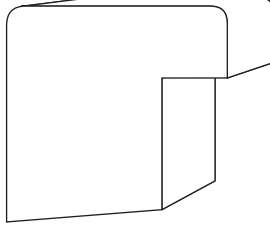

8378 1 1/8" x 1 1/8"

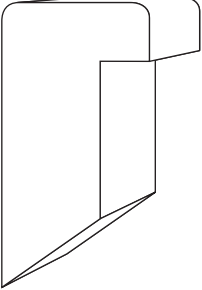

8379 3/4" x 1 1/2"

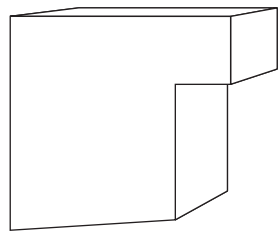

8713 1 1/8" x 1 1/8"

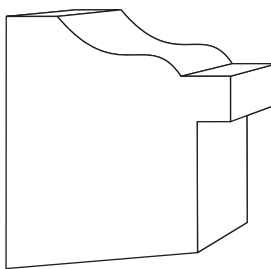

8387 1 1/8" x 1 5/16"

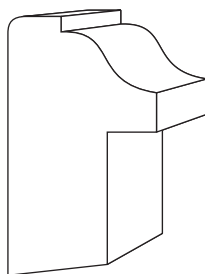

8315 3/4" x 1 3/8"

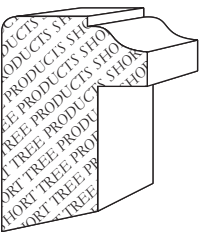

8314 3/4" x 1 1/8"



# BASE

BLC 004 5/8" x 4 1/2"

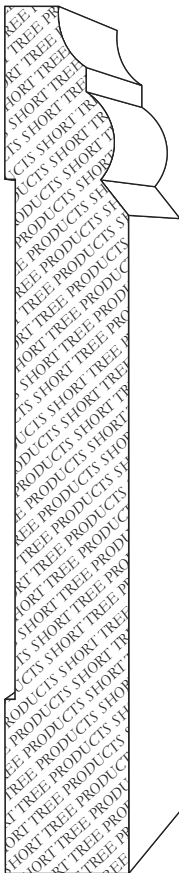

B-2 5/8" x 5"



BLC 008 5/8" x 5 3/8"

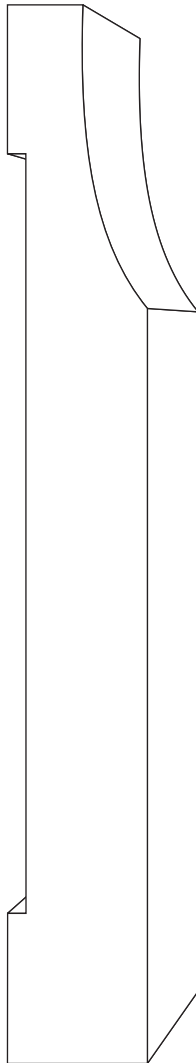

BLC 006 3/4" x 5 3/4"

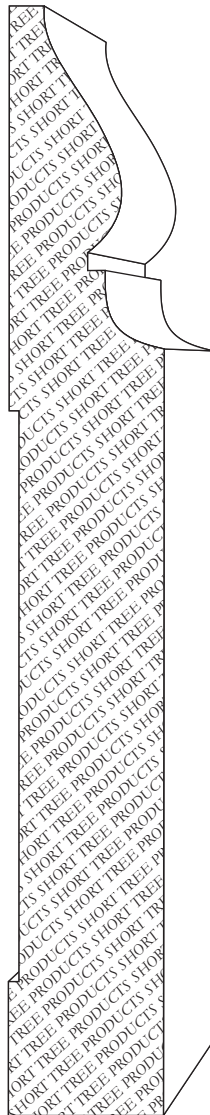

BLC 005 1 1/16" x 6"

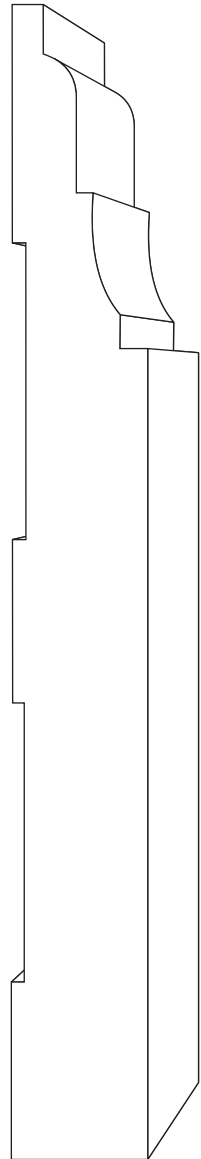



# BASE

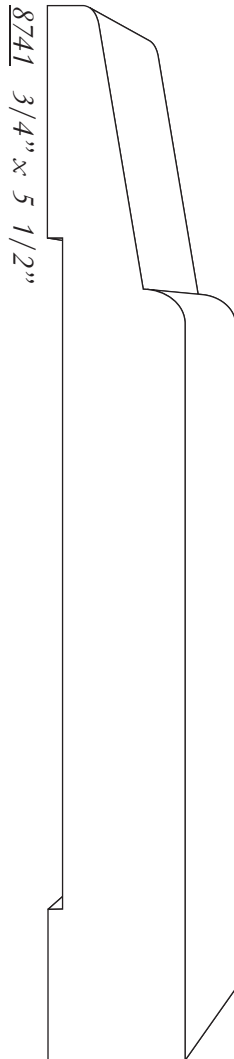
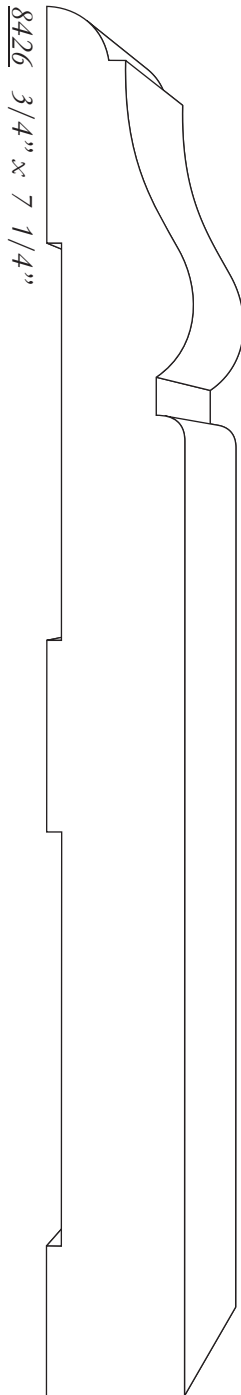
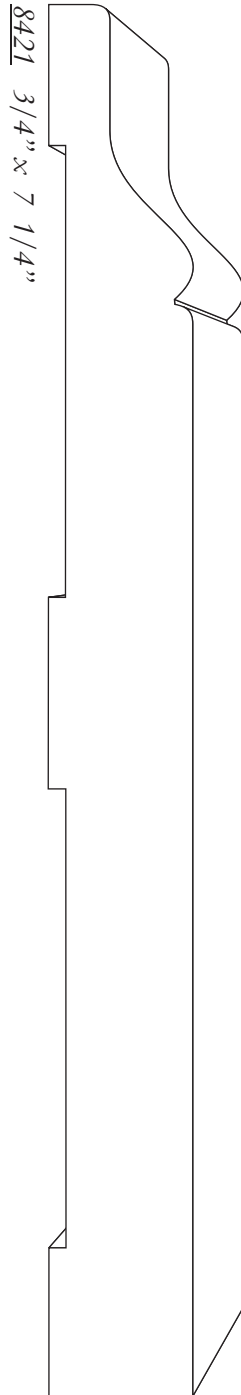
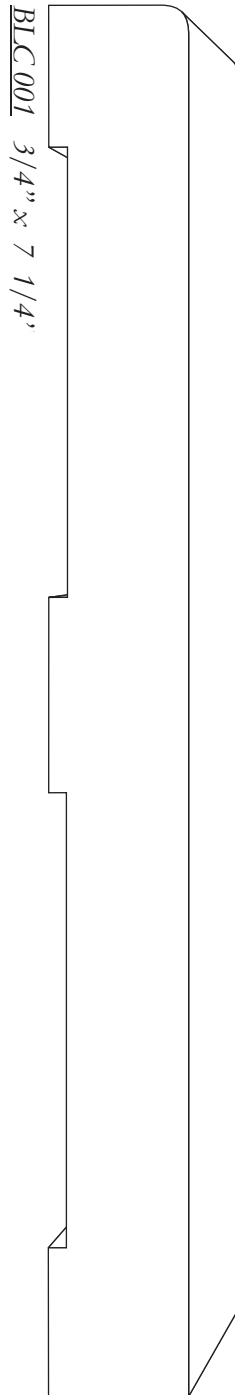
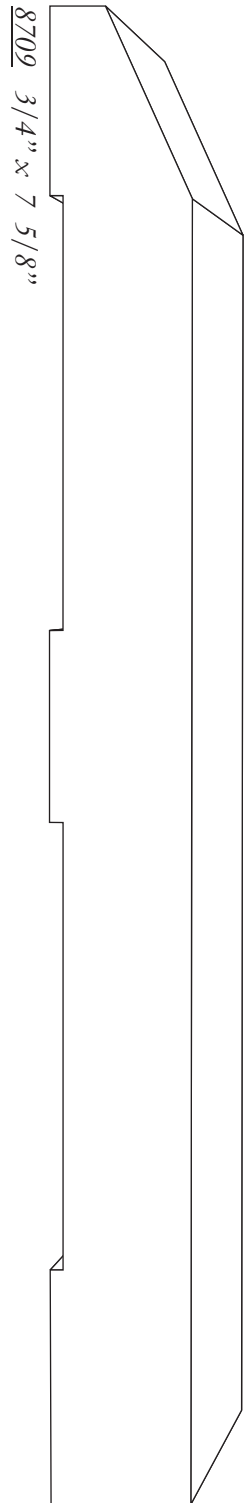

Ⓢ STOCKED OAK, POPLAR ONLY \* STOCKED OAK, POPLAR AND PINE

# BASE

8415 3/4" x 7 1/4"

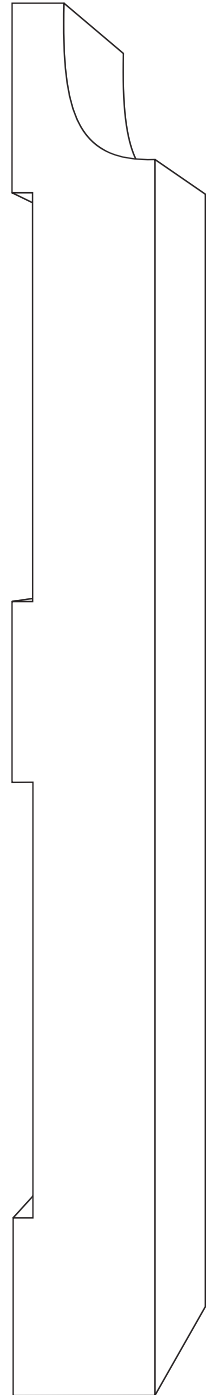

8728 3/4" x 5 5/8"

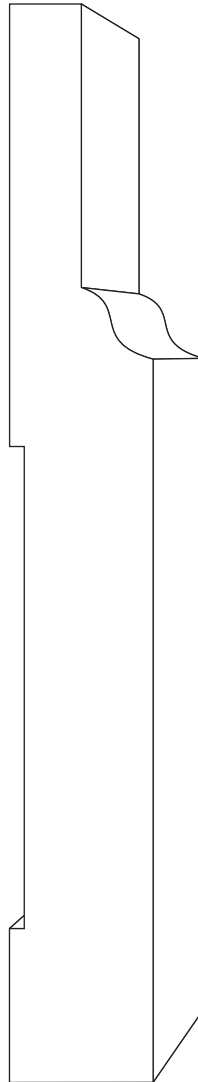

8716 3/4" x 5 1/2"

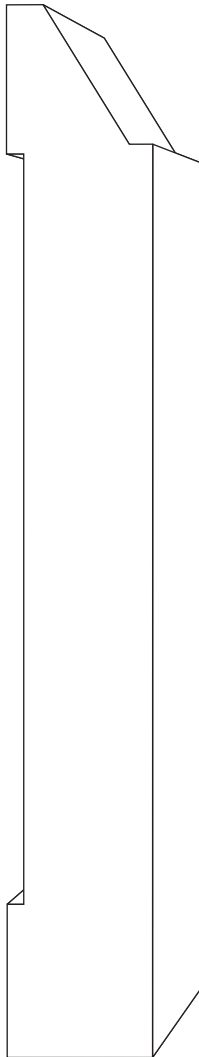

BLC002 5/8" x 3 1/2"



BLC011 5/8" x 3 1/2"

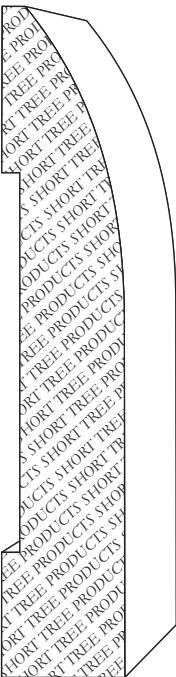

# BASE

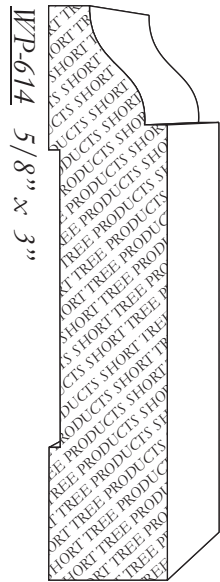

W/P-614 5/8" x 3"

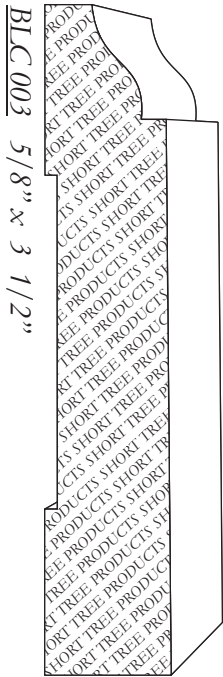

BLC 003 5/8" x 3 1/2"

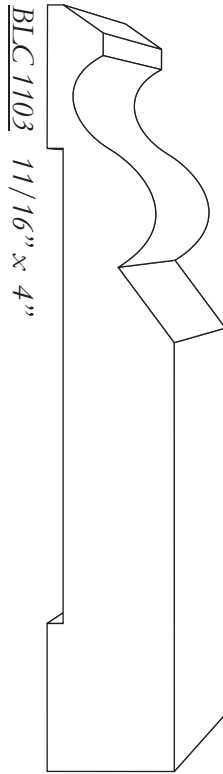

BLC 1103 11/16" x 4"

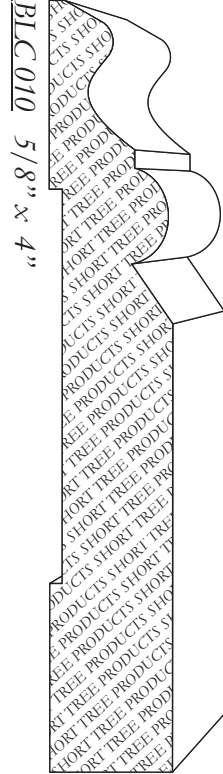

BLC 010 5/8" x 4"

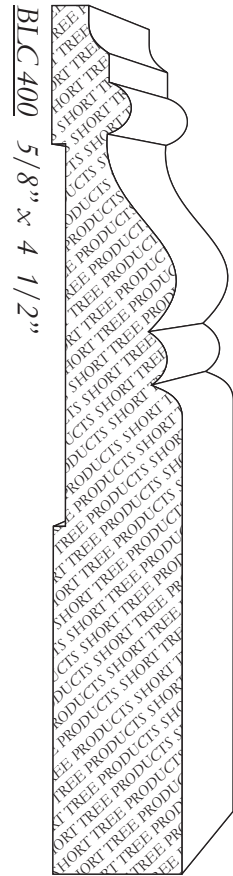

BLC 400 5/8" x 4 1/2"

# BASE SHOE

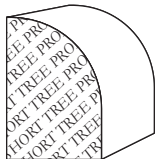

BLC 750  
1/2" x 3/4"

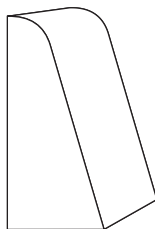

8425  
1/2" x 1 1/8"

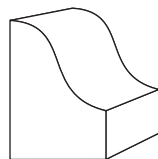

8423  
1/2" x 3/4"

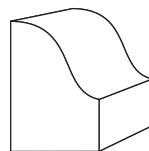

NY 114  
7/16" x 11/16"



© STOCKED OAK, POPLAR ONLY \* STOCKED OAK, POPLAR AND PINE

# BASE CAP

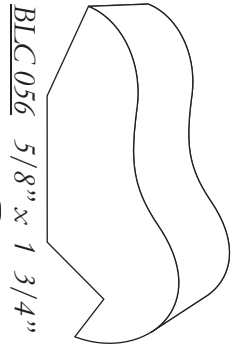

**BLC 056** 5/8" x 1 3/4"

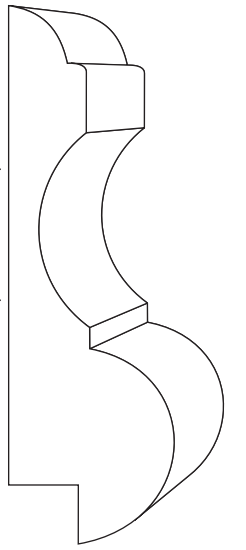

**BLC 053** 7/8" x 2 7/8"

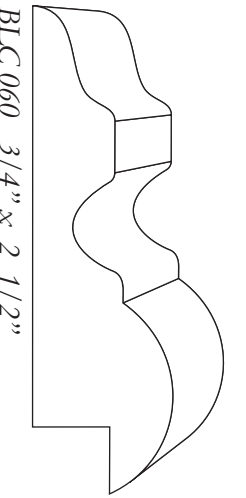

**BLC 060** 3/4" x 2 1/2"

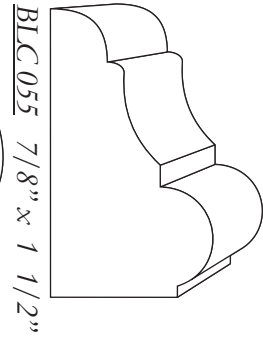

**BLC 055** 7/8" x 1 1/2"

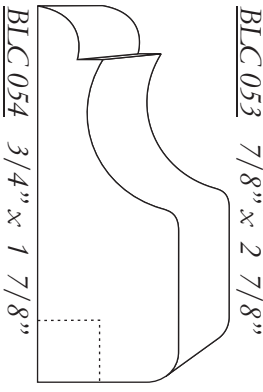

**BLC 054** 3/4" x 1 7/8"

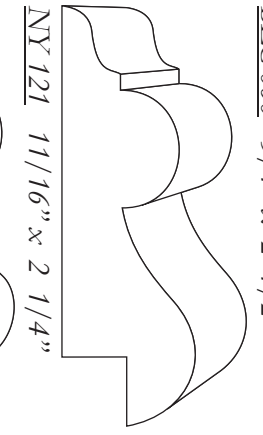

**NY 121** 11/16" x 2 1/4"

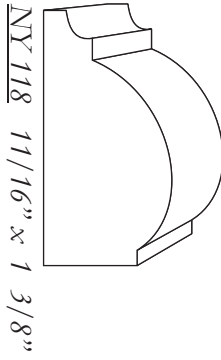

**NY 118** 11/16" x 1 3/8"

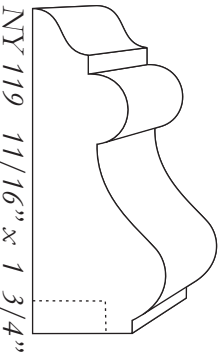

**NY 119** 11/16" x 1 3/4"



**NY 120** 11/16" x 2 1/4"

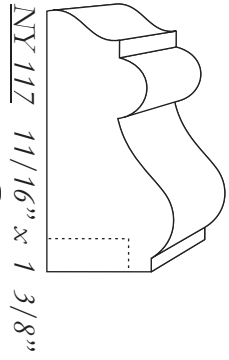

**NY 117** 11/16" x 1 3/8"

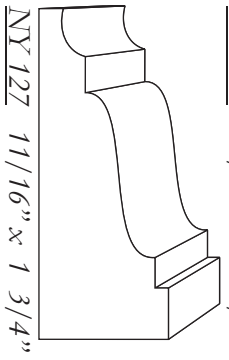

**NY 127** 11/16" x 1 3/4"

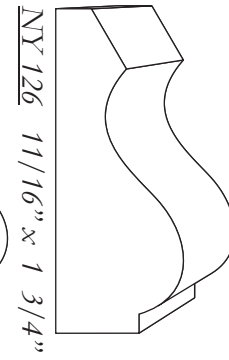

**NY 126** 11/16" x 1 3/4"

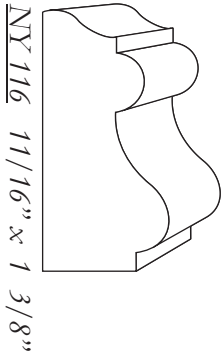

**NY 116** 11/16" x 1 3/8"

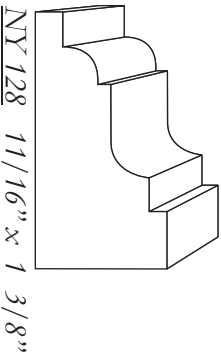

**NY 128** 11/16" x 1 3/8"



**NY 123** 11/16" x 1 3/4"

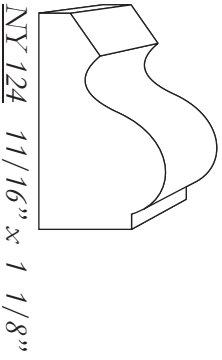

**NY 124** 11/16" x 1 1/8"

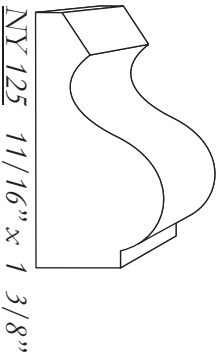

**NY 125** 11/16" x 1 3/8"

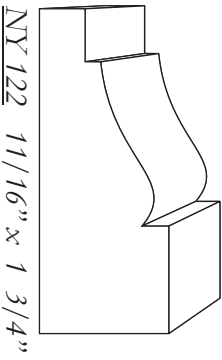

**NY 122** 11/16" x 1 3/4"



# BASE CAP

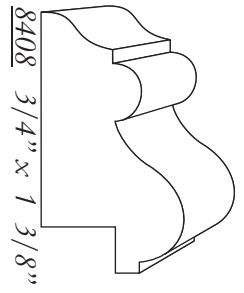

8408 3/4" x 1 3/8"



8414 3/4" x 2 3/4"

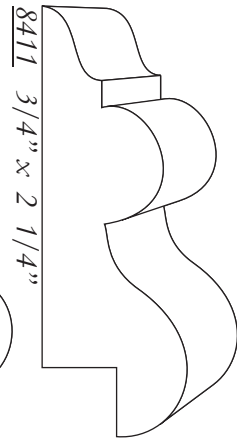

8411 3/4" x 2 1/4"

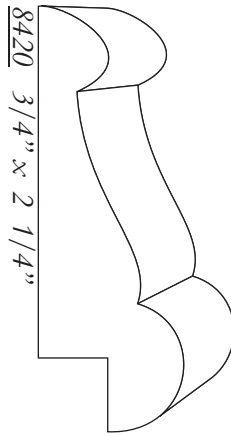

8420 3/4" x 2 1/4"

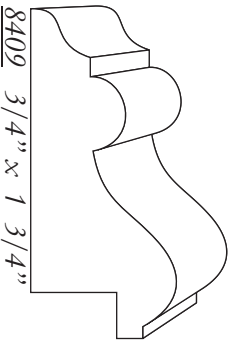

8409 3/4" x 1 3/4"

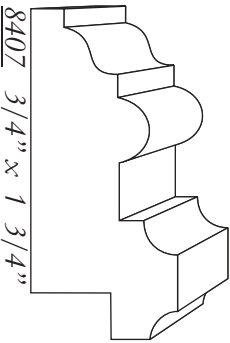

8407 3/4" x 1 3/4"

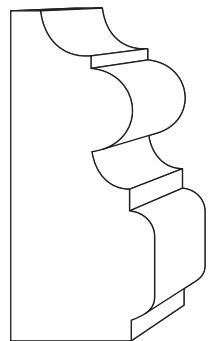

8406 3/4" x 1 3/4"

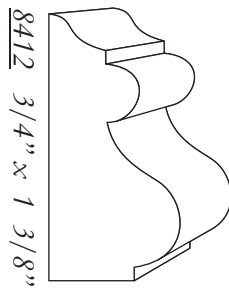

8412 3/4" x 1 3/8"

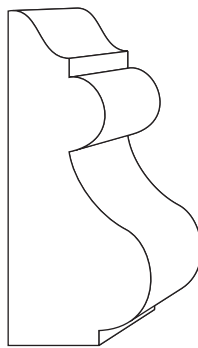

8416 3/4" x 1 3/4"



8417 3/4" x 2 1/4"

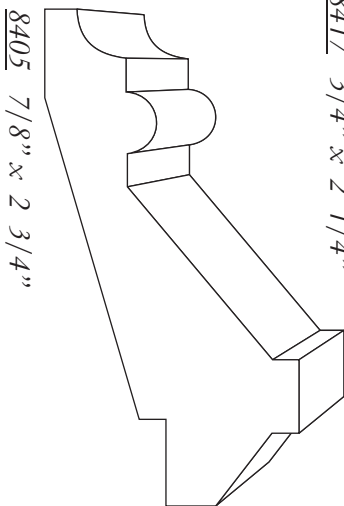

8405 7/8" x 2 3/4"

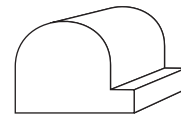

8449 1/2" x 5/8"

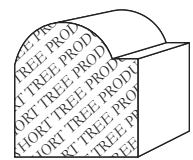

BLC 061 5/8" x 11/16"

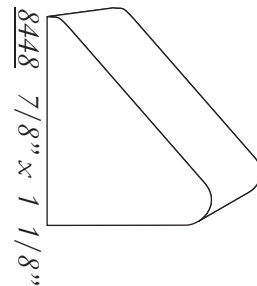

8448 7/8" x 1 1/8"



8447 3/4" x 1 3/4"

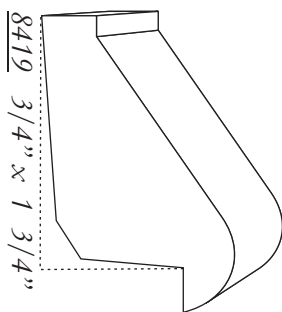

8419 3/4" x 1 3/4"

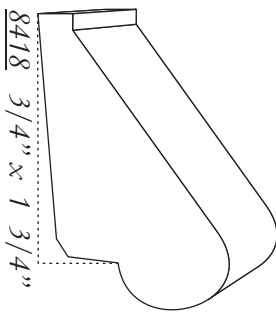

8418 3/4" x 1 3/4"



# CHAIR RAIL

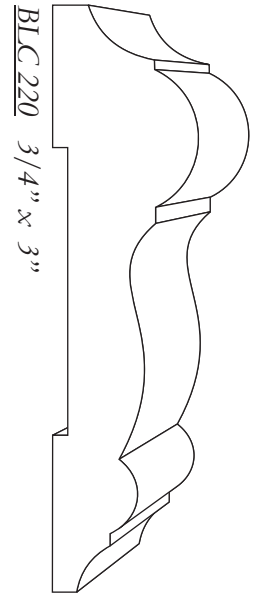

BLC 220 3/4" x 3"

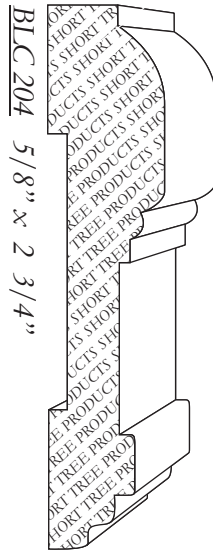

BLC 204 5/8" x 2 3/4"

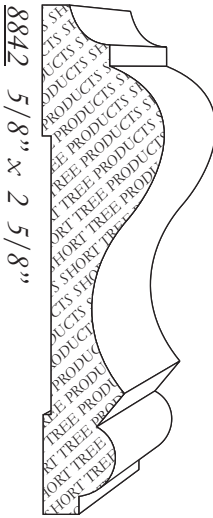

8842 5/8" x 2 5/8"

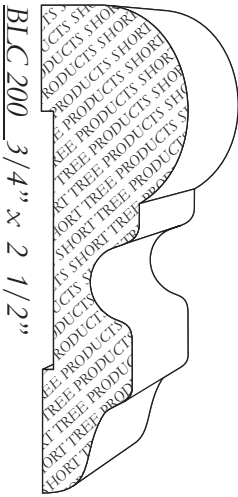

BLC 200 3/4" x 2 1/2"

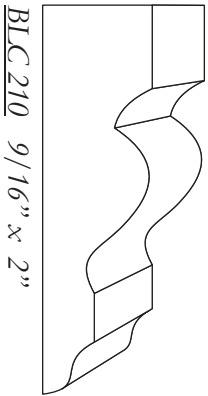

BLC 210 9/16" x 2"

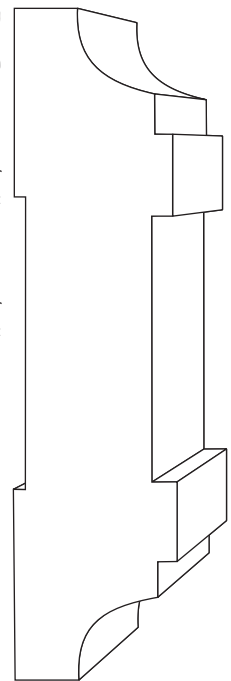

BLC 203 3/4" x 3 1/2"

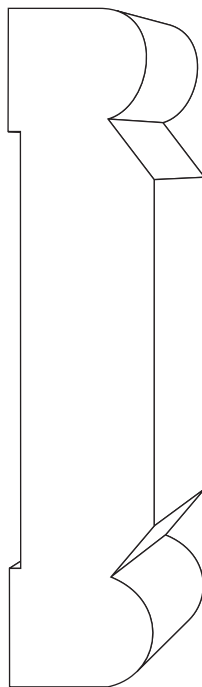

BLC 205 3/4" x 3 1/2"

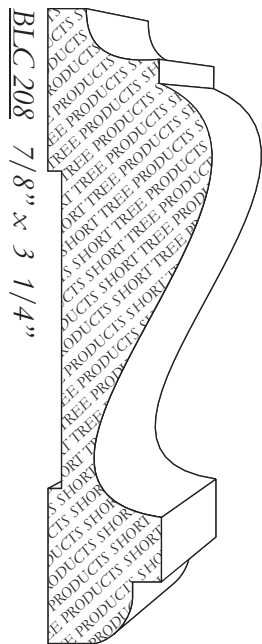

BLC 208 7/8" x 3 1/4"

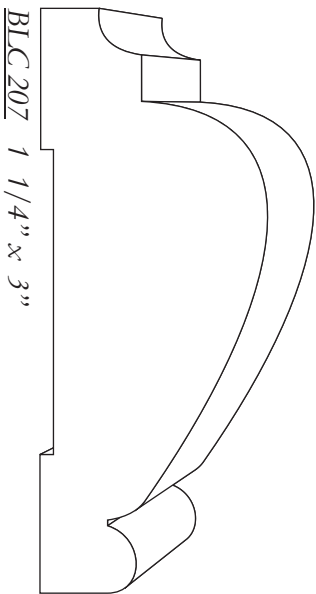

BLC 207 1 1/4" x 3"



# CHAIR RAIL

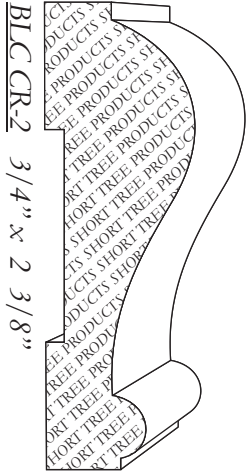

BLC CR-2 3/4" x 2 3/8"

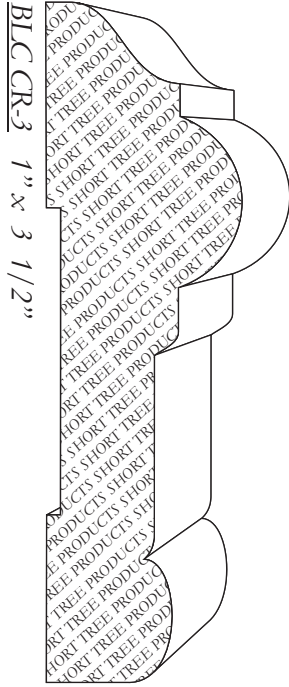

BLC CR-3 1" x 3 1/2"

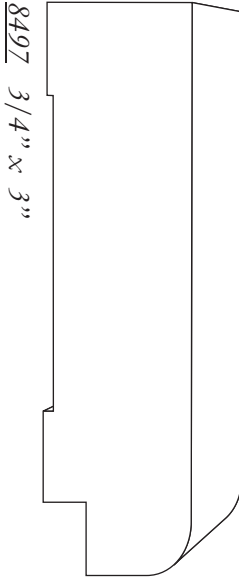

8497 3/4" x 3"

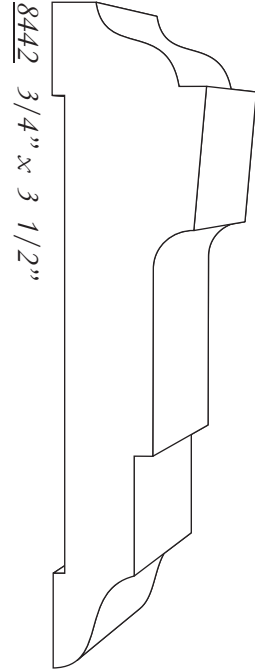

8442 3/4" x 3 1/2"

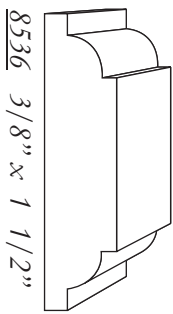

8536 3/8" x 1 1/2"

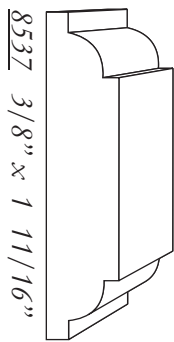

8537 3/8" x 1 11/16"

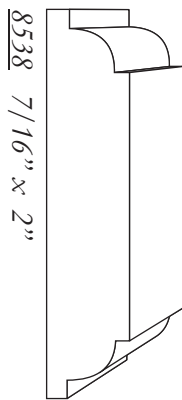

8538 7/16" x 2"

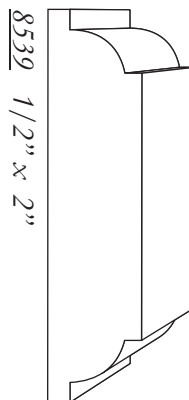

8539 1/2" x 2"



# CHAIR RAIL

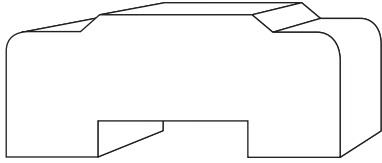

8271 3/4" x 1 3/4"

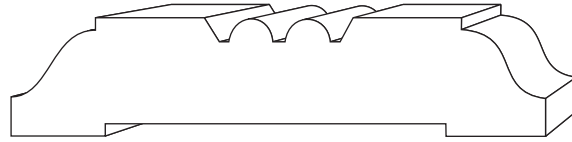

8187 5/8" x 2 3/4"

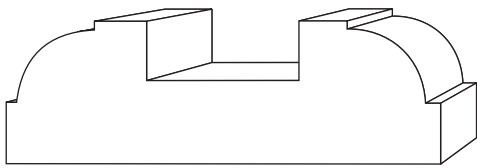

8273 3/4" x 2 1/4"

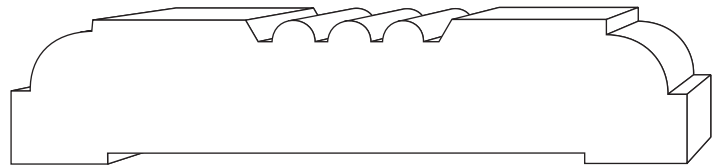

8222 3/4" x 3 1/2"

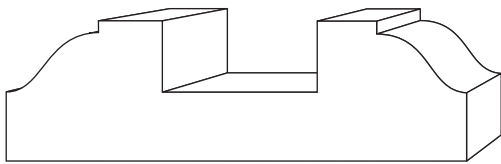

8277 3/4" x 2 3/8"

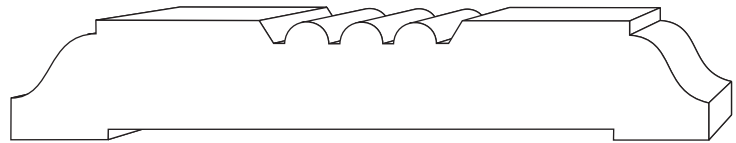

8186 5/8" x 3 5/8"

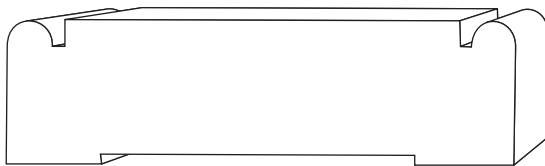

8188 3/4" x 2 5/8"

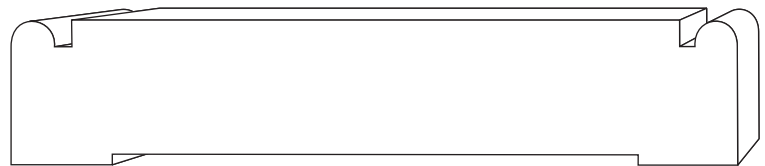

8189 3/4" x 3 3/4"





# CHAIR RAIL & CAP

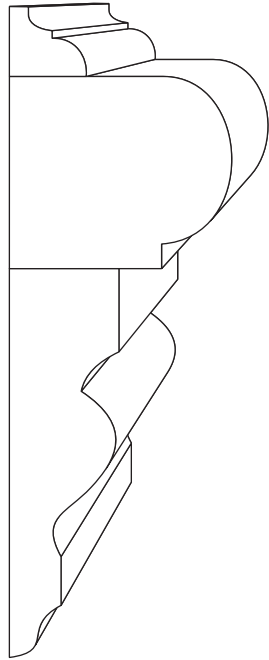

8570-A 3/8" x 3/8"

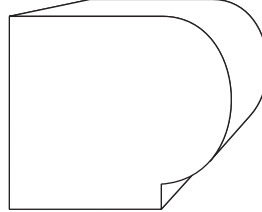

BLC 211 1" x 1 1/16"

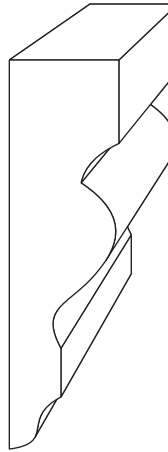

BLC 210 9/16" x 2"

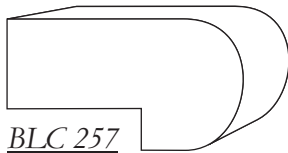

BLC 257  
1 1/16" x 1 1/4"

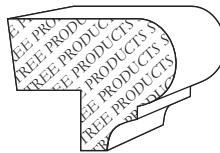

\*BLC 258  
1 1/16" x 7/8"

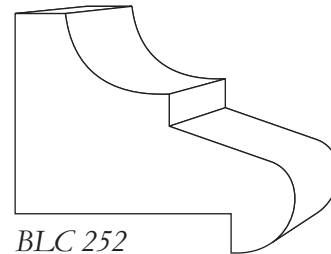

BLC 252  
1 1/4" x 1 1/2"



BLC 255  
1 1/16" x 1 1/4"

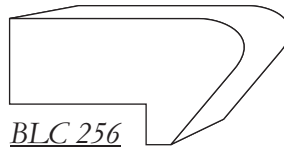

BLC 256  
5/8" x 1 3/16"

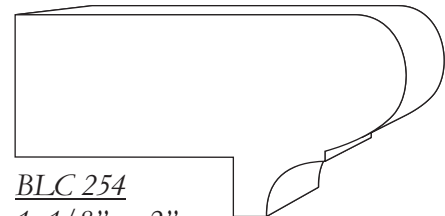

BLC 254  
1 1/8" x 2"



# PICTURE MOULD

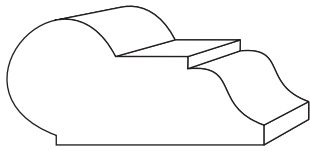

NY 104 11/16" x 1 3/8"

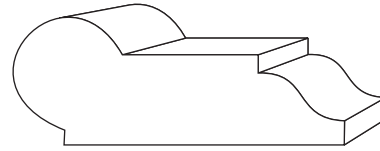

NY 103 11/16" x 1 3/4"

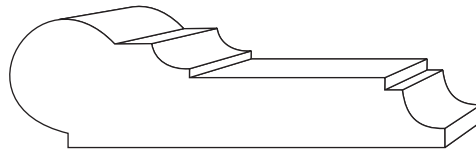

NY 102 11/16" x 2 1/4"

# PICTURE FRAME

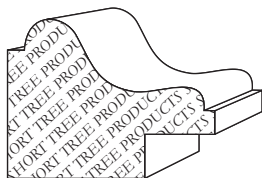

BLC 651 13/16" x 1 1/16"

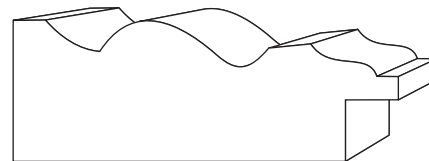

BLC 653 3/4" x 2"



BLC 652 3/4" x 1 3/8"



BLC 655 3/4" x 2 1/4"



BLC 656 3/4" x 1 3/4"

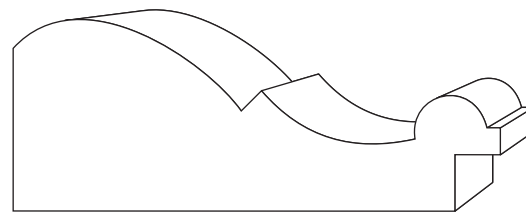

BLC 654 1" x 2 1/2"



# PANEL MOULD



MOULD A 3/8" x 5/8"



BLC 609 5/16" x 1"

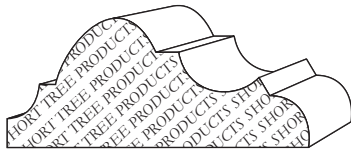

BLC 613 5/8" x 1 9/16"

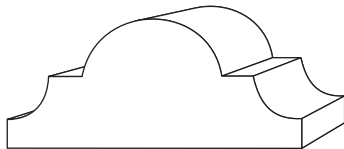

BLC 603 5/8" x 1 1/2"

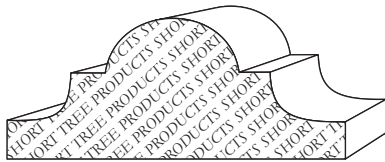

BLC 602 11/16" x 1 3/4"



BLC 606 3/8" x 2"

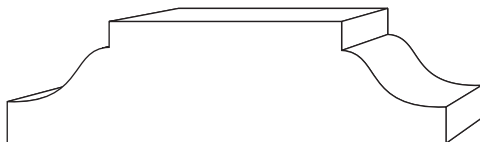

BLC 201 5/8" x 2 1/4"

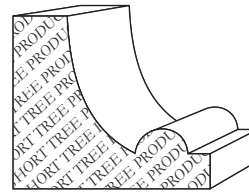

BLC 621 7/8" x 1"

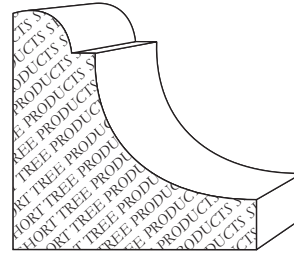

BLC 622 1 1/4" x 1 1/4"

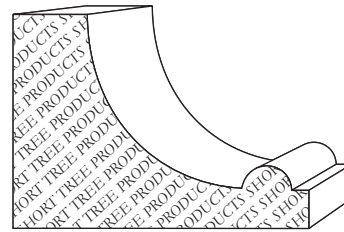

BLC 620 1 1/8" x 1 1/2"

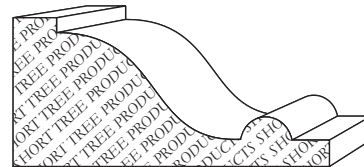

BLC 614 3/4" x 1 5/8"

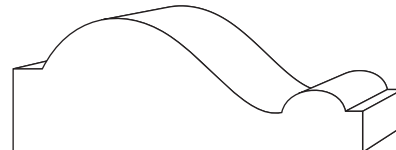

BLC 626 11/16" x 1 3/4"

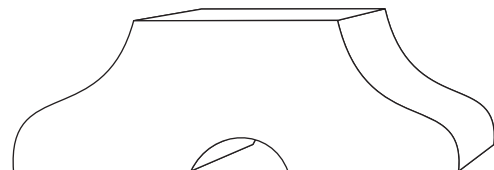

BLC 630 3/4" x 2 1/4"



# PANEL MOULD

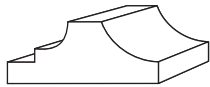

BLC 607 5/16" x 3/4"



BLC 608 1/2" x 3/4"

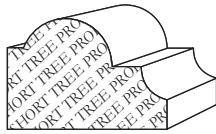

BLC 611 9/16" x 13/16"

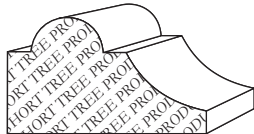

BLC 628 5/8" x 1"

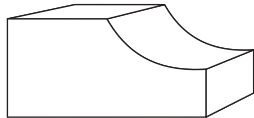

BLC 610 5/8" x 1"



BLC 601 1/2" x 1 1/8"

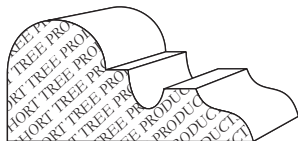

1505 5/8" x 1 1/4"



BLC 604 9/16" x 1 9/16"

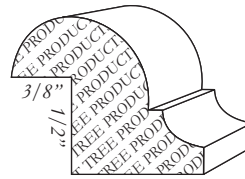

BLC 640 13/16" x 1"

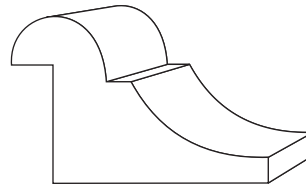

BLC 616 7/8" x 1 1/4"

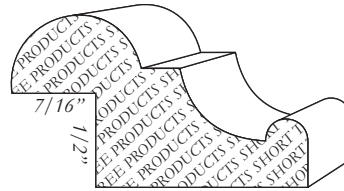

BLC 615 7/8" x 1 1/2"

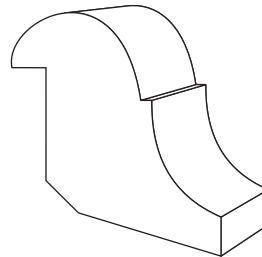

BLC 618 1 1/4" x 1 1/4"

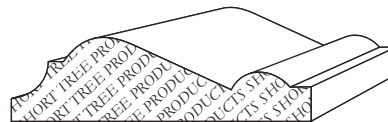

BLC 605 7/16" x 1 1/2"

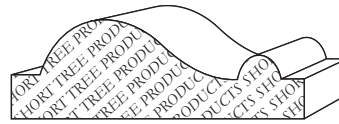

BLC 625 1/2" x 1 1/2"



BLC 617 11/16" x 1 1/2"

# PANEL & BASE MOULD

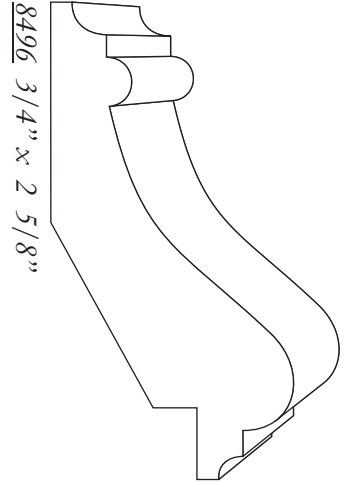

8496 3/4" x 2 5/8"

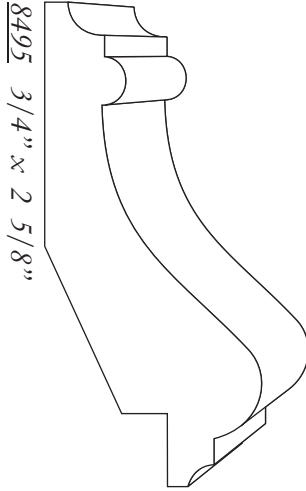

8495 3/4" x 2 5/8"

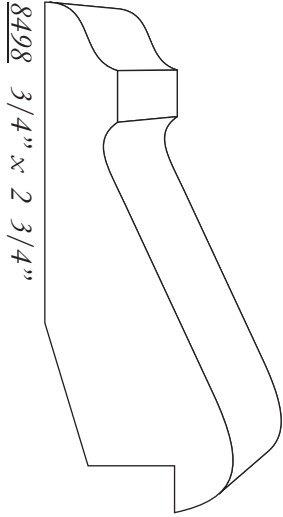

8498 3/4" x 2 3/4"

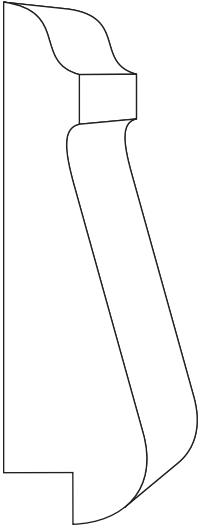

8499 3/4" x 2 3/4"

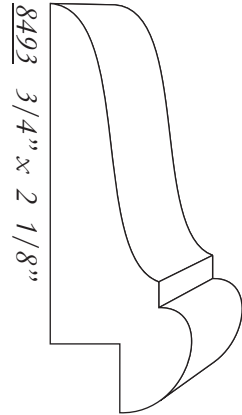

8493 3/4" x 2 1/8"

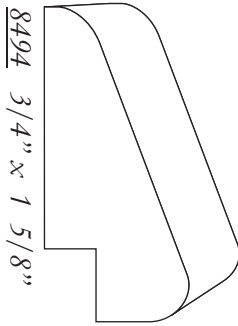

8494 3/4" x 1 5/8"

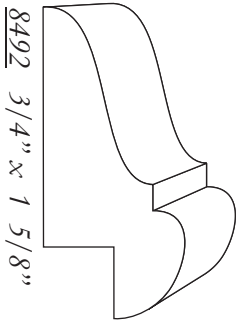

8492 3/4" x 1 5/8"

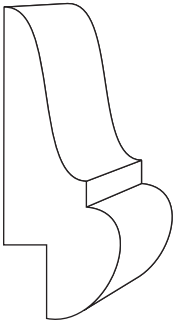

8454 5/8" x 1 5/8"







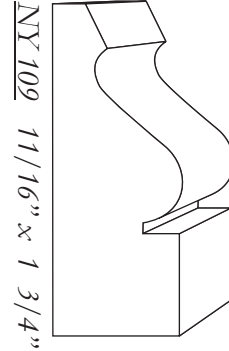
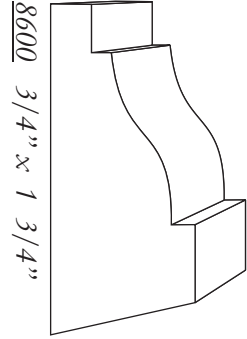
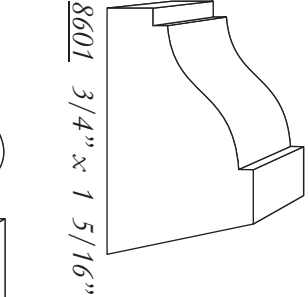
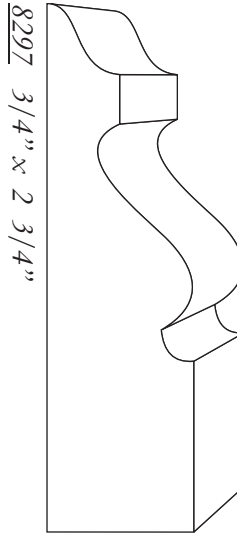
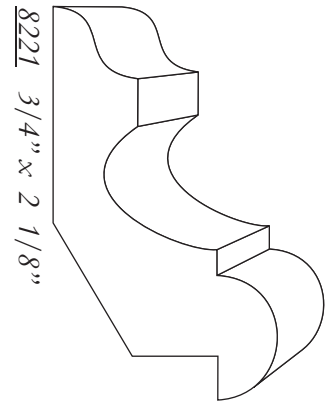
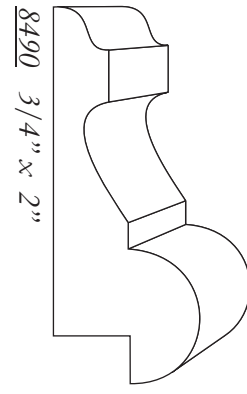
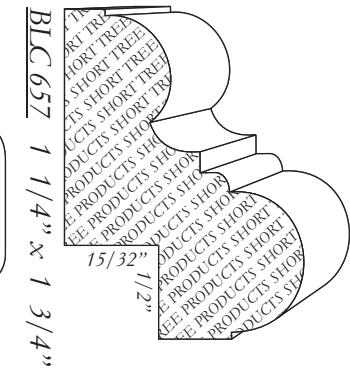
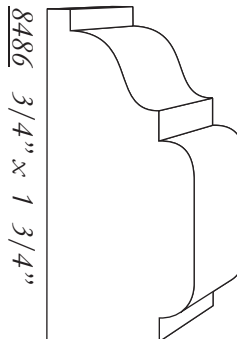
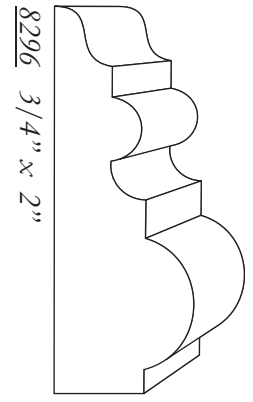
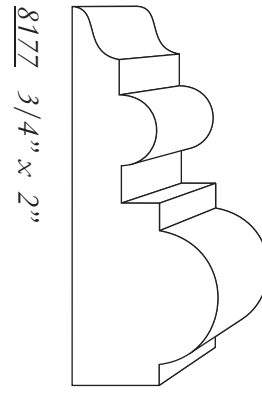
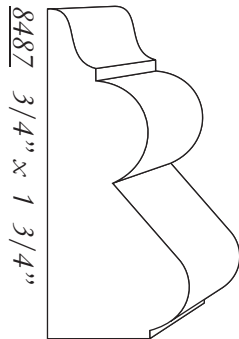
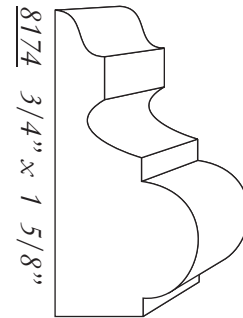
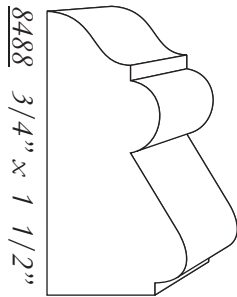
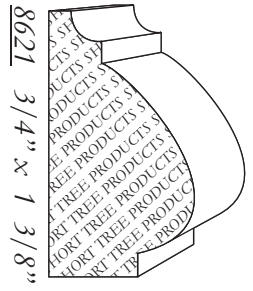
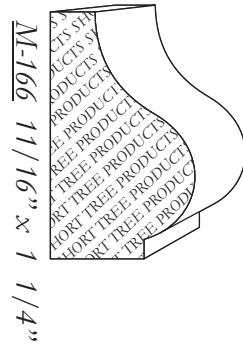
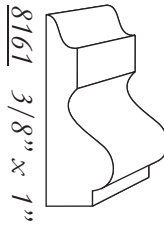
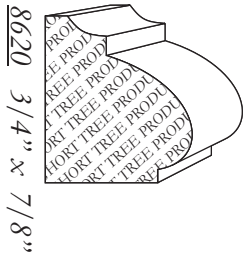
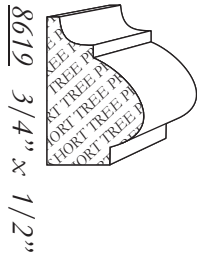

Ⓢ STOCKED OAK, POPLAR ONLY \* STOCKED OAK, POPLAR AND PINE

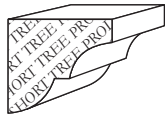
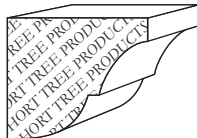
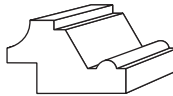
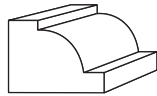

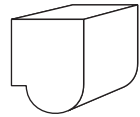
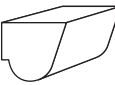
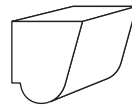
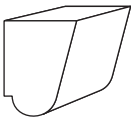
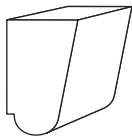
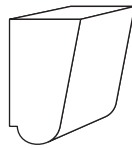

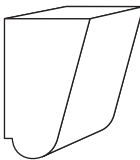

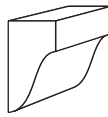
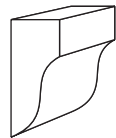
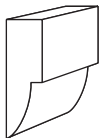
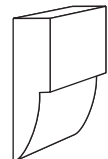
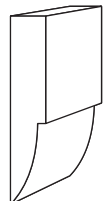
# PANEL & BAND MOULD

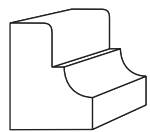
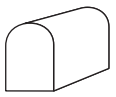
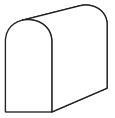

# GLASS BEAD

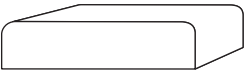
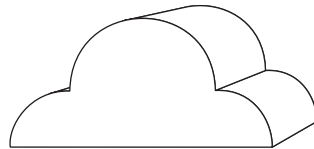
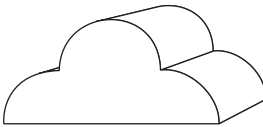
<u>8570A</u> 3/8" x 3/8" 	<u>8570B</u> 1/2" x 1/2" 	<u>8570C</u> 5/8" x 3/4" 	<u>8589</u> 3/8" x 5/8" 	<u>8590</u> 3/8" x 1/2" 	<u>8540</u> 1/4" x 3/4" 	<u>8562</u> 3/8" x 1/2" 
<u>8581</u> 5/16" x 5/16" 	<u>8563</u> 3/8" x 7/16" 	<u>8569</u> 3/8" x 1/2" 	<u>8568</u> 3/8" x 5/8" 	<u>8567</u> 3/8" x 11/16" 	<u>8566</u> 3/8" x 3/4" 	<u>8565</u> 7/16" x 3/4" 
<u>8579</u> 1/4" x 3/8" 	<u>8580</u> 3/16" x 3/8" 	<u>8583</u> 1/4" x 1/2" 	<u>8584</u> 1/4" x 5/8" 	<u>8586</u> 3/16" x 5/8" 	<u>8587</u> 3/16" x 3/4" 	<u>8588</u> 3/16" x 1" 

# SCREEN MOULD

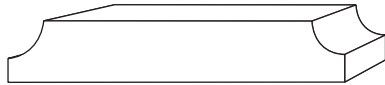
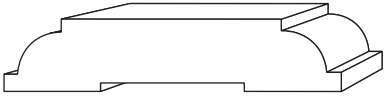
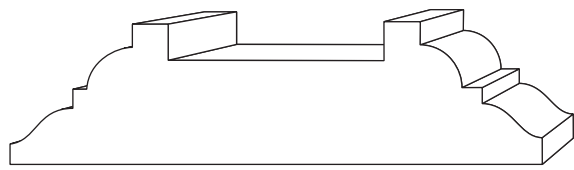
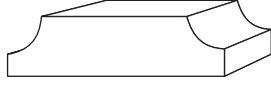
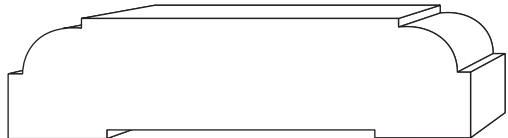
					
<u>8564</u> 7/16" x 9/16"	<u>8561</u> 1/4" x 3/8"	<u>8560</u> 1/4" x 1/2"	<u>8611</u> 1/4" x 3/4"	<u>8610</u> 1/4" x 3/4"	<u>8134</u> 1/4" x 1"
					
<u>8142</u> 11/16" x 1 3/8"	<u>8141</u> 9/16" x 1 1/8"	<u>8140</u> 3/8" x 3/4"	<u>8139</u> 5/16" x 5/8"		
					
<u>8128</u> 5/16" x 1 1/8"	<u>8137</u> 5/16" x 1 3/4"	<u>8138</u> 3/8" x 1 3/4"			
					
<u>8127</u> 3/4" x 2 3/4"	<u>8136</u> 5/16" x 1 1/8"				
					
<u>8126</u> 5/8" x 2 3/8"					



STOCKED OAK, POPLAR ONLY \*STOCKED OAK, POPLAR AND PINE

# QUARTER ROUND



8057  
1/4" x 1/4"



8058  
3/8" x 3/8"

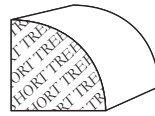

8063  
1/2" x 1/2"

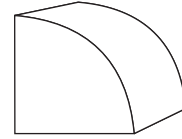

8064  
5/8" x 5/8"

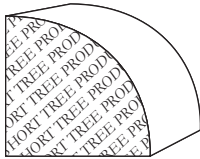

\*BLC 954  
3/4" x 3/4"

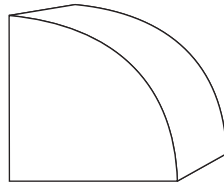

8066  
7/8" x 7/8"

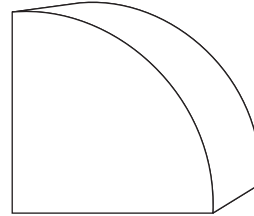

8068  
1 1/16" x 1 1/16"

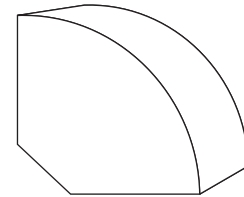

8067  
3/4" x 1 3/8"

# HALF ROUND



8069  
3/16" x 3/8"



8075  
1/4" x 7/16"



8070  
1/4" x 1/2"

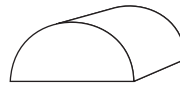

8076  
5/16" x 5/8"

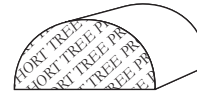

BLC 904  
3/8" x 3/4"

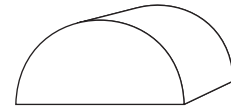

8071  
7/16" x 7/8"

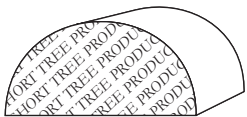

8078  
1/2" x 1"

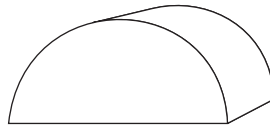

8072  
9/16" x 1 1/8"

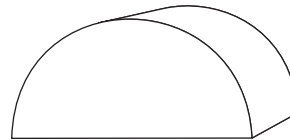

8079  
5/8" x 1 1/4"

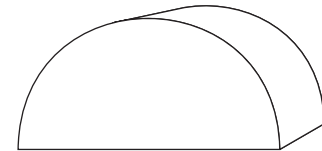

8073  
11/16" x 1 3/8"

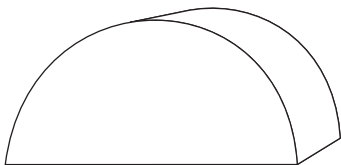

8081  
3/4" x 1 1/2"

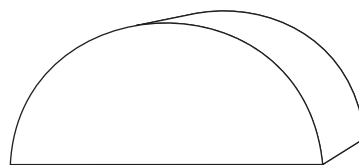

8080  
3/4" x 1 5/8"

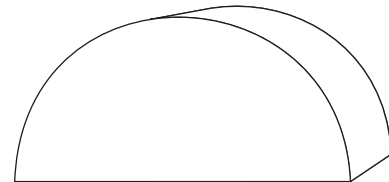

8074  
7/8" x 1 3/4"





# CAP & SHOE



8193 5/16" x 1 3/4"

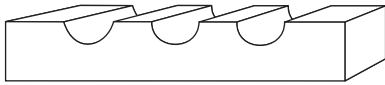

8191 5/16" x 1 3/4"

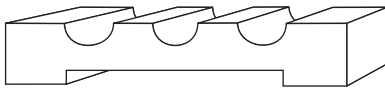

8192 5/16" x 1 3/4"

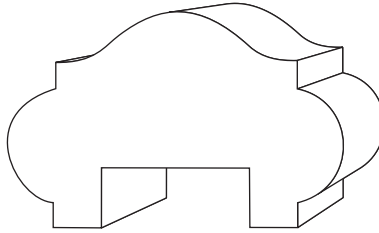

8276 1 1/8" x 1 3/4"

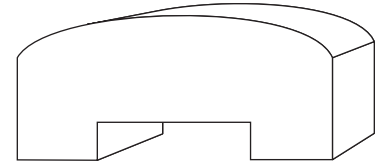

8275 3/4" x 1 5/8"

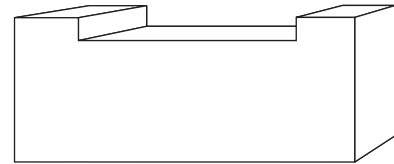

8194 3/4" x 1 3/4"

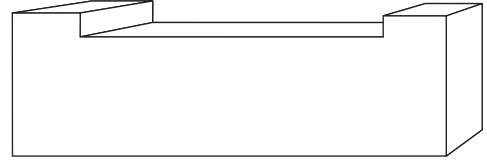

8195 3/4" x 2 1/4"

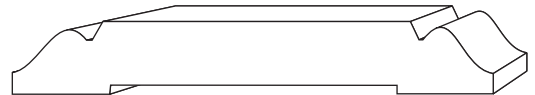

8190 3/8" x 2 1/2"

# LATTICE



8279 1/4" x 7/8"



8281 5/16" x 1 3/8"

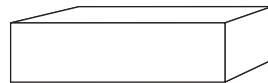

8280 5/16" x 1 1/8"



LATTICE 1/4" x 1 5/8"

# LANDING TREAD

3 1/2" 1 1/32" x 3 1/2"

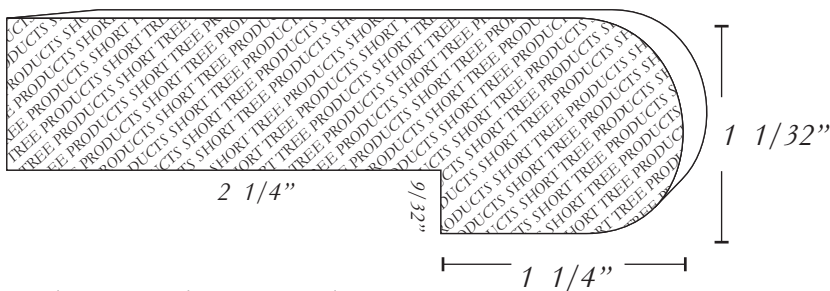

5 1/2" 1 1/32" x 5 1/2"

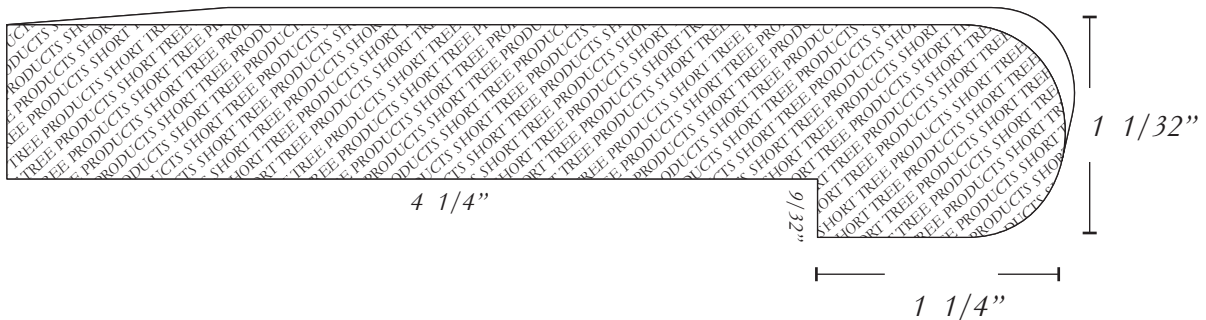

© STOCKED OAK, POPLAR ONLY \* STOCKED OAK, POPLAR AND PINE

# NOSE & COVE

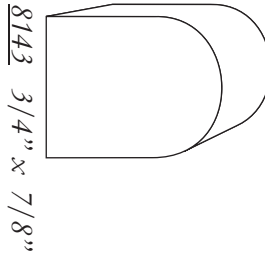

8143 3/4" x 7/8"

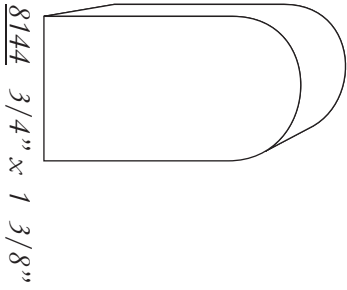

8144 3/4" x 1 3/8"

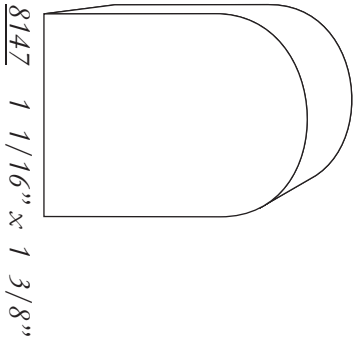

8147 1 1/16" x 1 3/8"

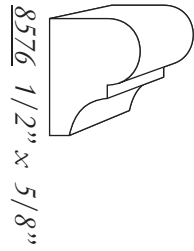

8576 1/2" x 5/8"

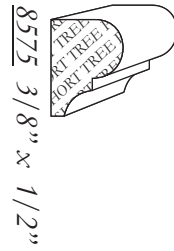

8575 3/8" x 1/2"

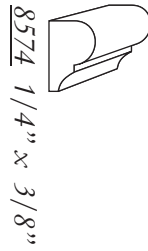

8574 1/4" x 3/8"

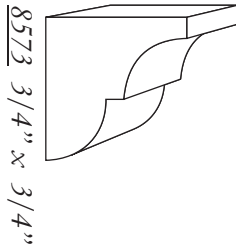

8573 3/4" x 3/4"

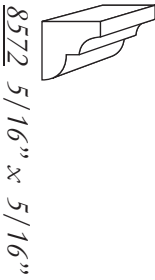

8572 5/16" x 5/16"

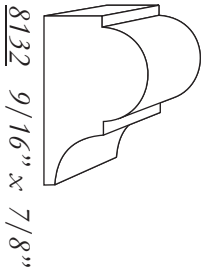

8132 9/16" x 7/8"

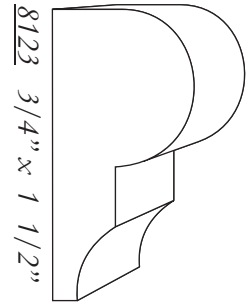

8123 3/4" x 1 1/2"

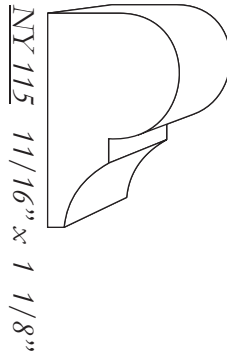

NY 115 11/16" x 1 1/8"

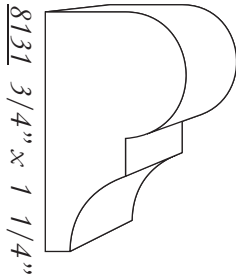

8131 3/4" x 1 1/4"

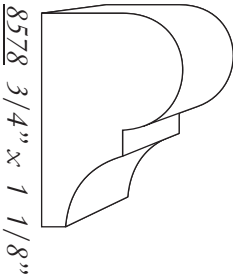

8578 3/4" x 1 1/8"

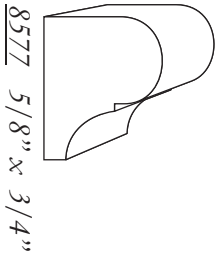

8577 5/8" x 3/4"

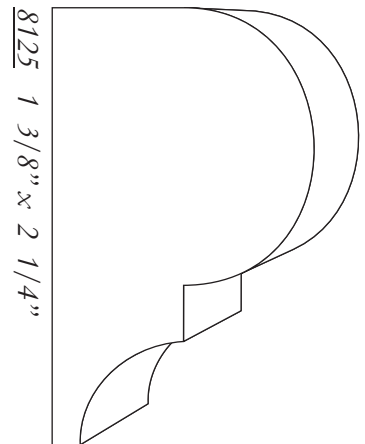

8125 1 3/8" x 2 1/4"

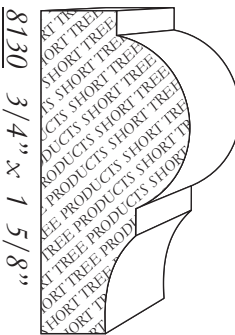

8130 3/4" x 1 5/8"

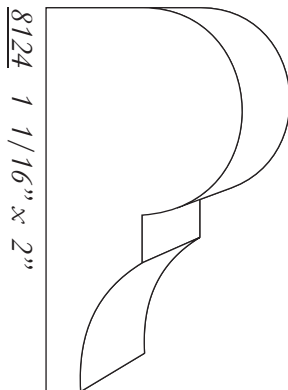

8124 1 1/16" x 2"

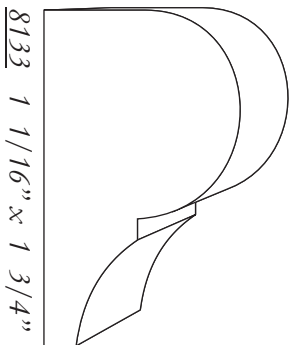

8133 1 1/16" x 1 3/4"



# BED & COVE

BLC 892  
1/2" x 1/2"



\*BLC 893  
3/4" x 3/4"

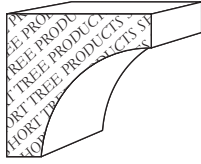

8062  
5/8" x 3/4"

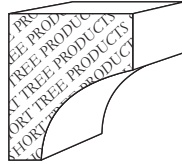

8059  
1/2" x 7/8"

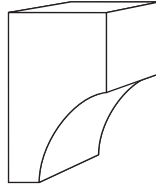

8060  
3/4" x 7/8"

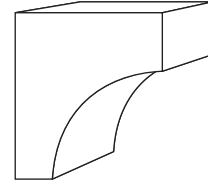

8054  
1 1/16" x 1 1/16"

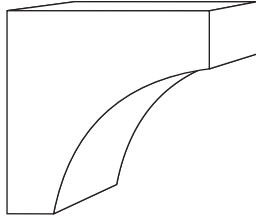

8061  
3/4" x 1 1/8"

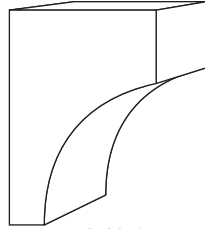

8500  
3/4" x 3/4"

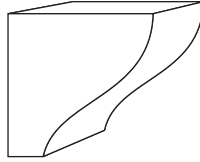

8501  
3/4" x 1 1/16"

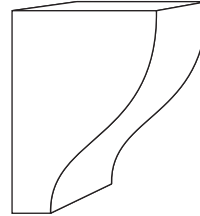

8502  
3/4" x 1 5/8"

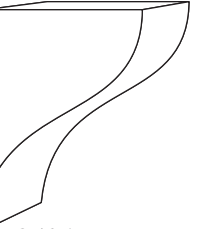

8505  
3/4" x 1 3/4"

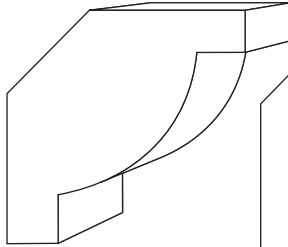

8506  
3/4" x 1 3/4"

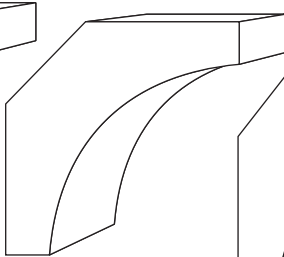

8532  
3/4" x 2"

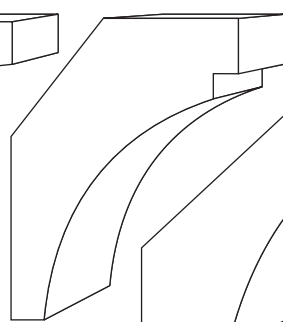

8503  
3/4" x 2 3/4"

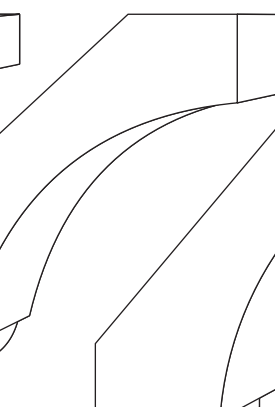

8504  
3/4" x 3 1/4"



8507  
5/8" x 1 5/16"

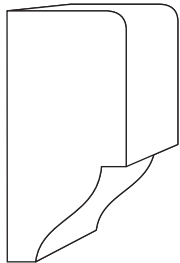

8531  
3/4" x 1"

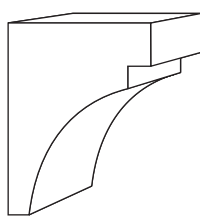

8535  
5/8" x 7/8"

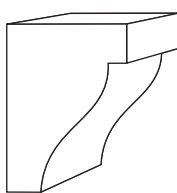

8530  
5/8" x 5/8"

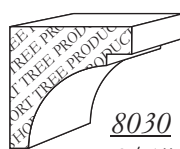

8033  
3/4" x 2 3/4"

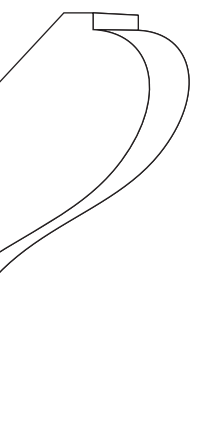

8031  
3/4" x 1 3/4"

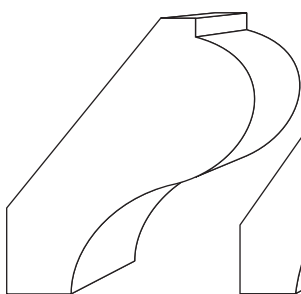

8032  
3/4" x 2"

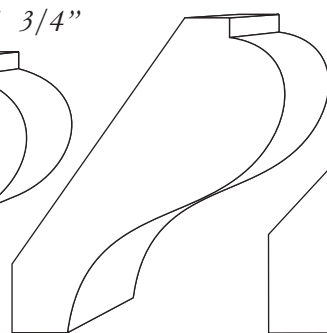

8030  
3/4" x 2 1/4"

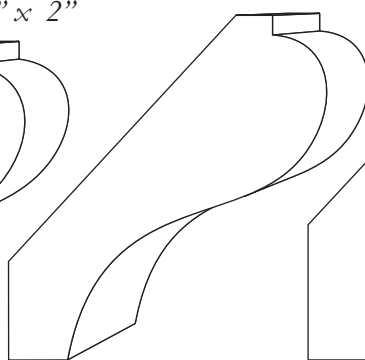

# BED & COVE

BLC 301  
3/4" x 1 3/4"

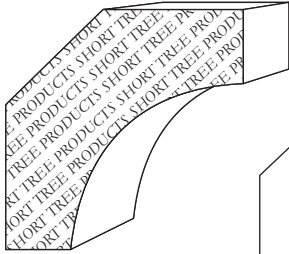

8025  
3/4" x 2 1/4"

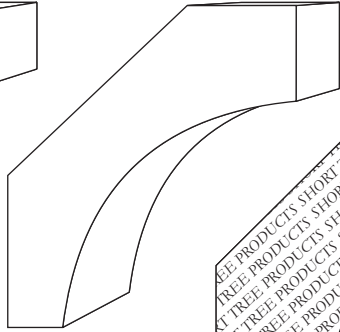

BLC 302  
3/4" x 2 3/4"

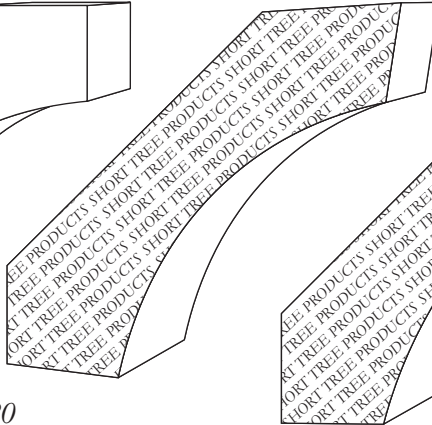

8029  
3/4" x 3 1/4"

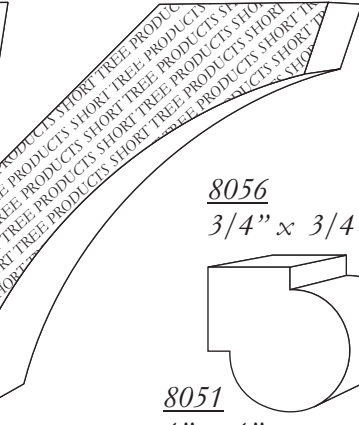

8018  
3/4" x 2 1/4"

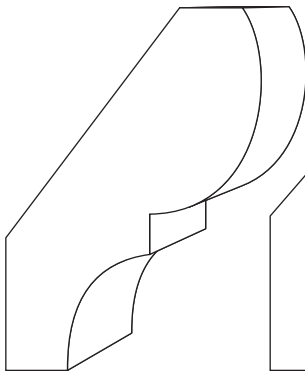

8520  
3/4" x 2"

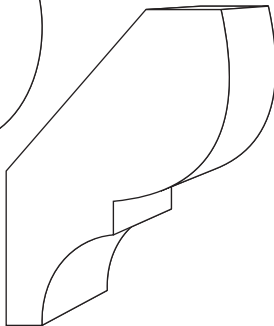

BLC 355  
3/4" x 1 3/4"

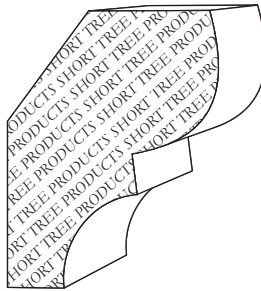

8056  
3/4" x 3/4"

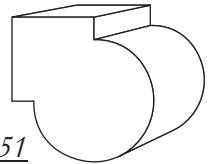

8051  
1" x 1"

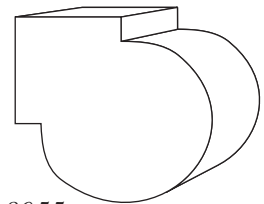

8055  
1 1/16" x 1 1/16"

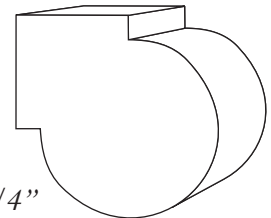

BLC 358  
3/4" x 2 3/4"

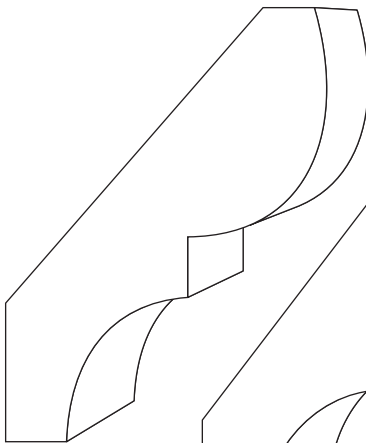

8020  
3/4" x 3 1/4"

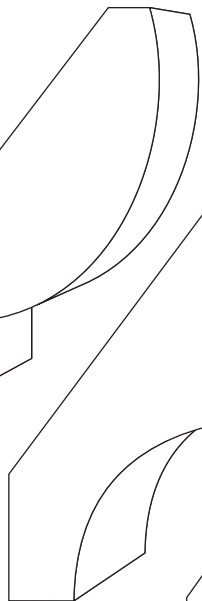

8023  
3/4" x 3 5/8"

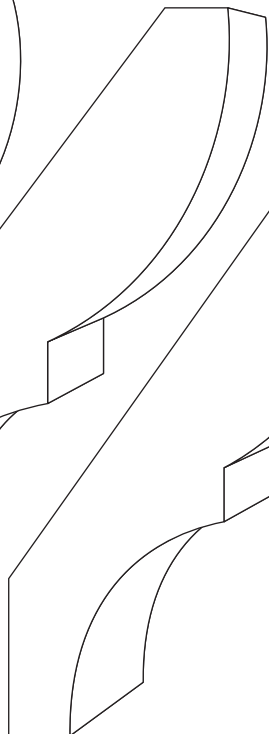

8021  
3/4" x 4 1/4"

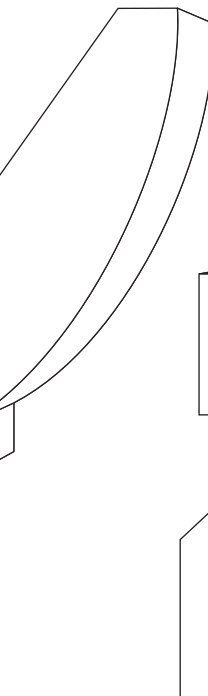

8015  
3/4" x 1"

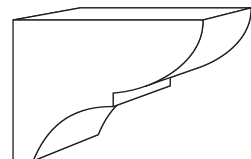

8017  
3/4" x 1 1/2"

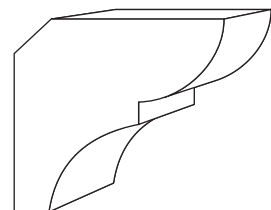

# CROWN MOULD

BLC 303  
3/4" x 2 5/8"

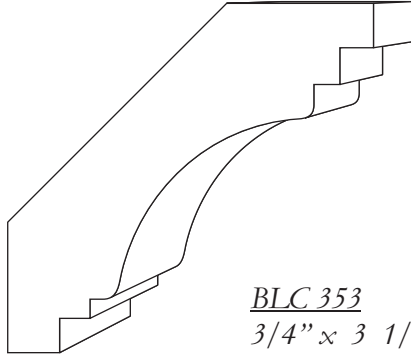

8625  
1" x 1 1/4"

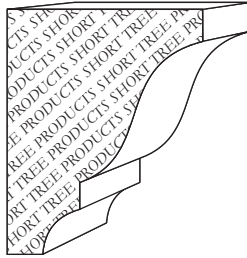

NY 108  
11/16" x 1 3/4"

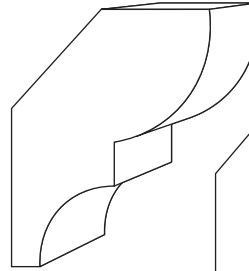

8624  
3/4" x 2 1/4"

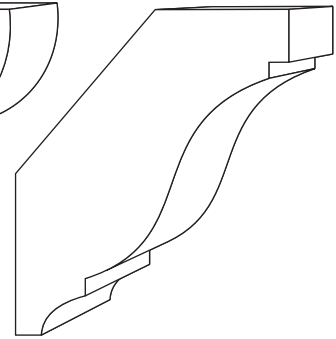

BLC 353  
3/4" x 3 1/2"

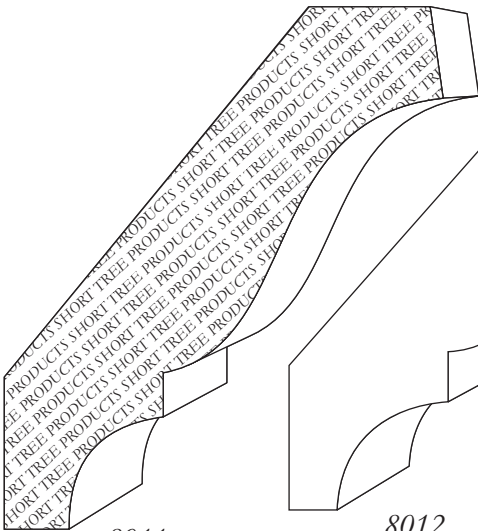

8014  
3/4" x 3 1/4"

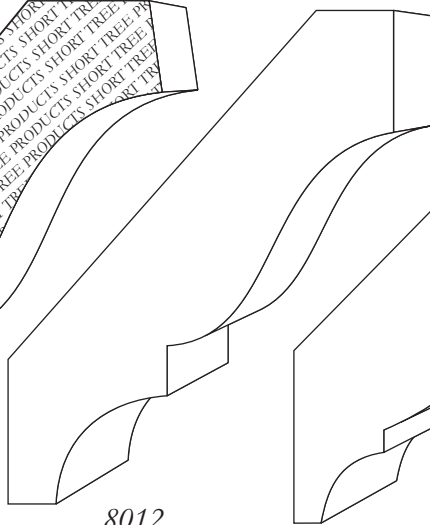

8623  
3/4" x 3 1/4"

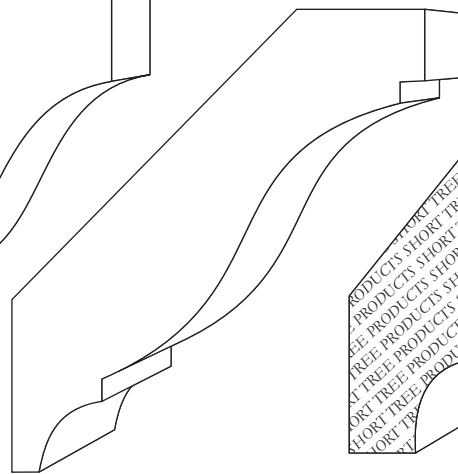

BLC 354  
3/4" x 2 3/4"

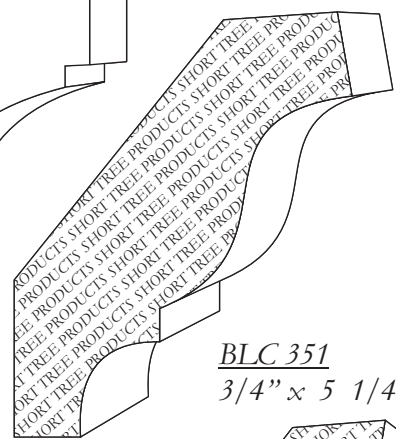

8011  
3/4" x 2 1/4"

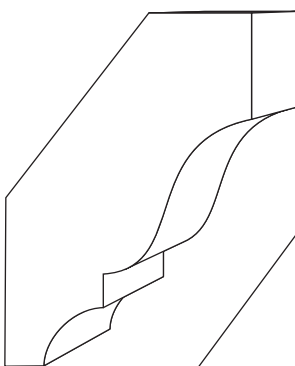

8012  
3/4" x 4 1/4"

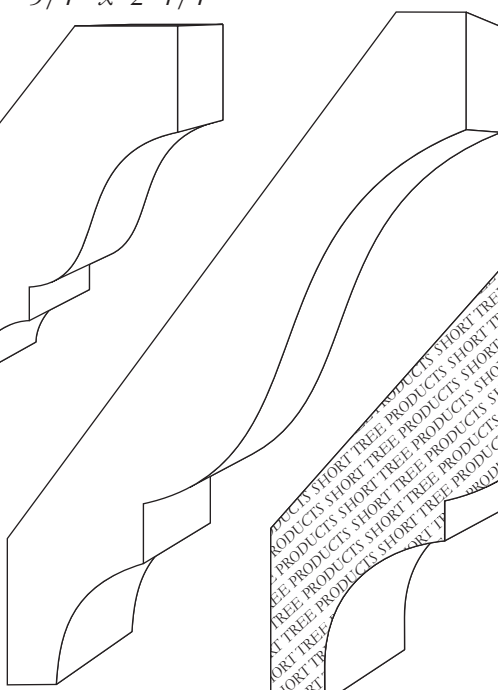

BLC 352  
3/4" x 4 1/2"

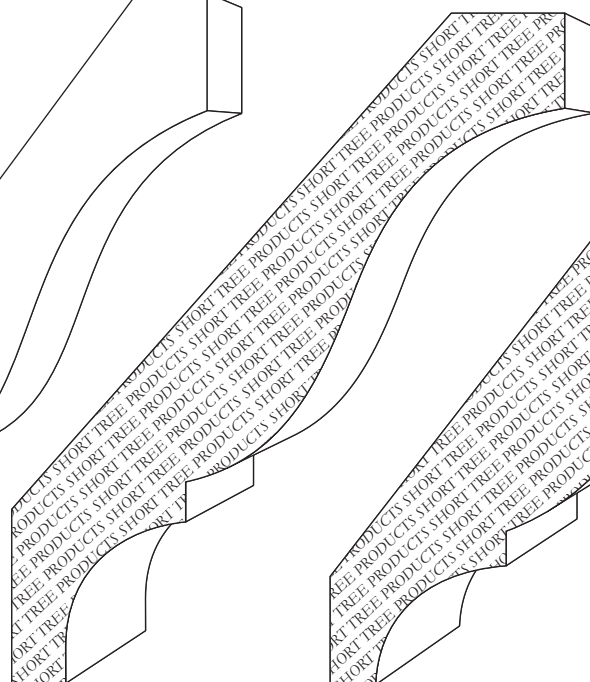

BLC 351  
3/4" x 5 1/4"

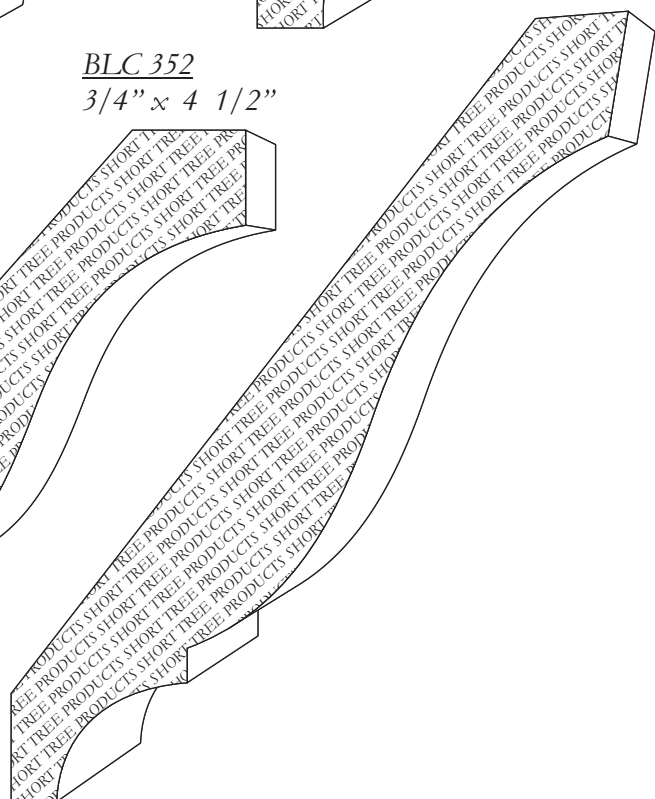

© STOCKED OAK, POPLAR ONLY \* STOCKED OAK, POPLAR AND PINE

# CROWN MOULD

8007

3/4" x 1 3/4"

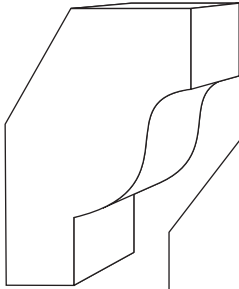

8008

3/4" x 2 1/4"

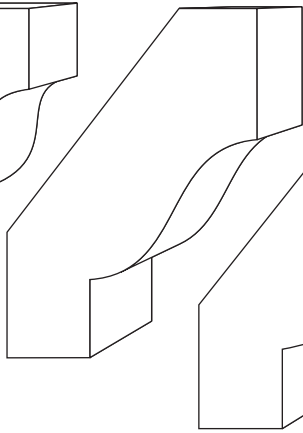

8003

3/4" x 2 3/4"

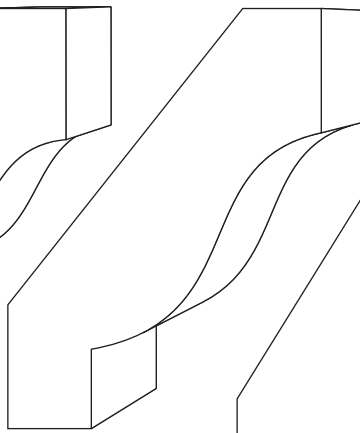

8000

3/4" x 3 1/4"

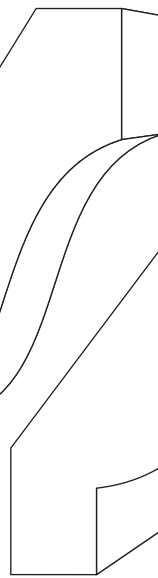

8002

3/4" x 3 5/8"

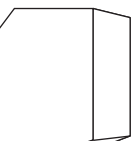

8006

3/4" x 4 1/4"

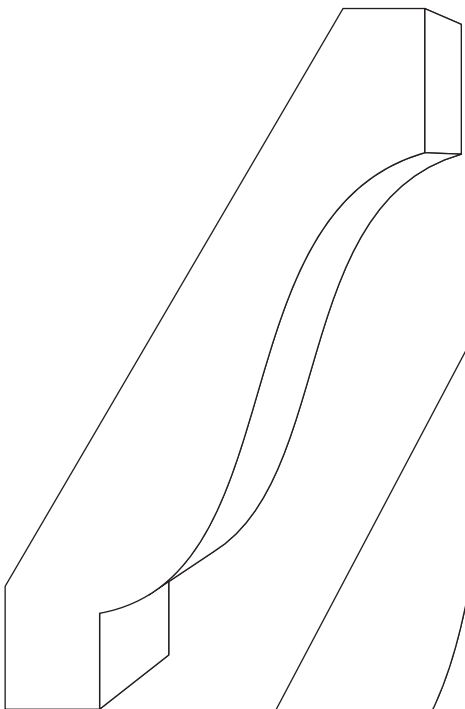

8005

3/4" x 4 5/8"



8004

3/4" x 5 1/4"

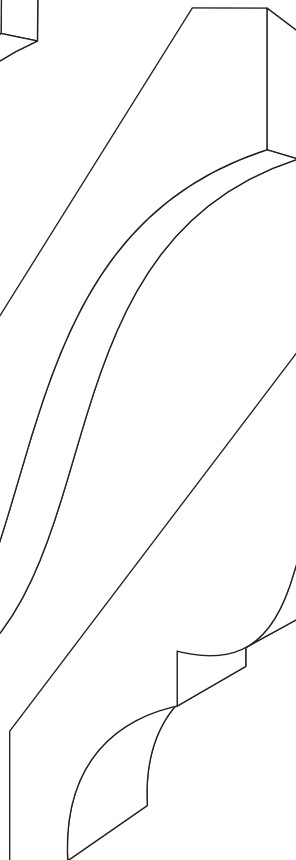

8022

3/4" x 4 3/4"



Ⓢ STOCKED OAK, POPLAR ONLY \* STOCKED OAK, POPLAR AND PINE



# CROWN MOULD

BLC 304  
1 1/16" x 4 1/8"

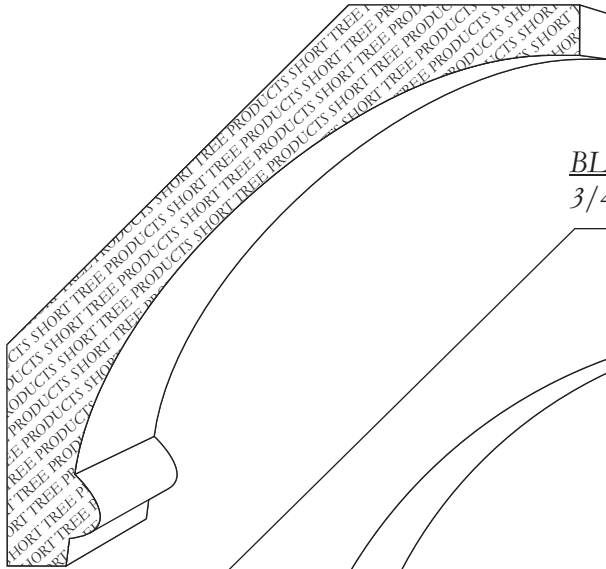

BLC 361  
3/4" x 4 5/8"

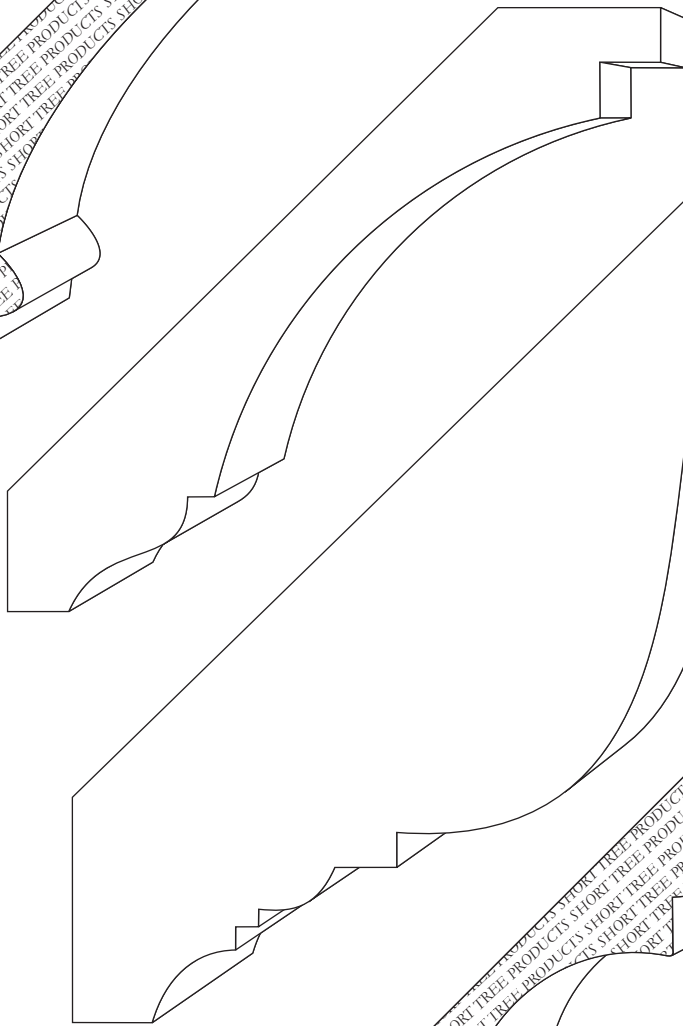

BLC 362  
1 3/4" x 7 1/2"

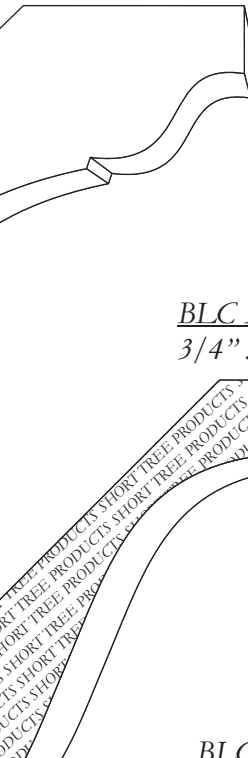

BLC 356  
3/4" x 6"

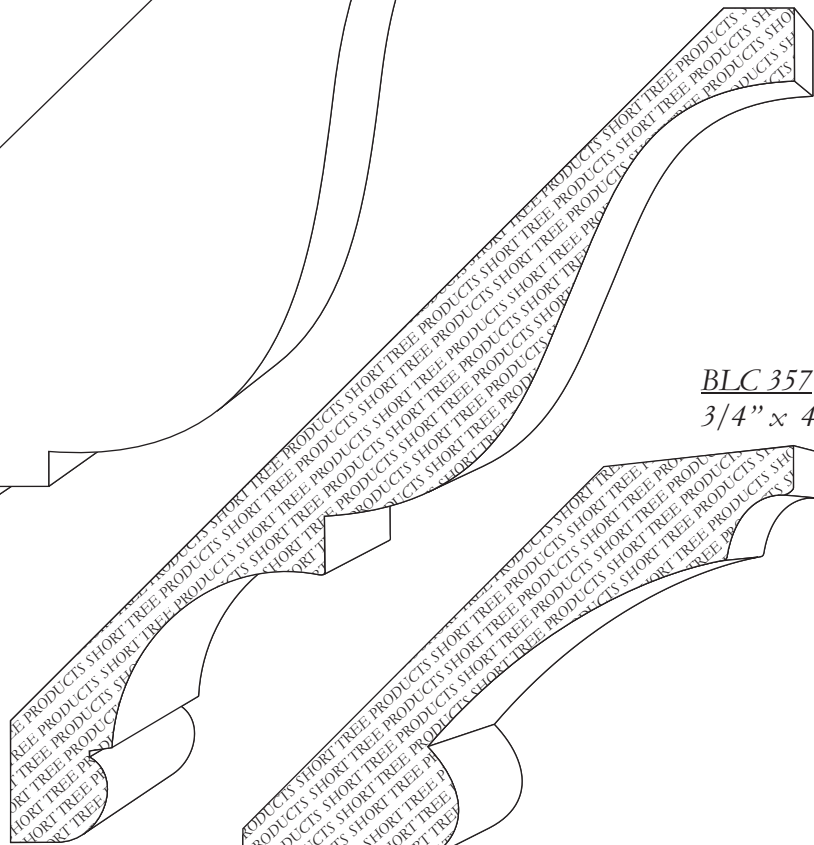

BLC 357  
3/4" x 4"

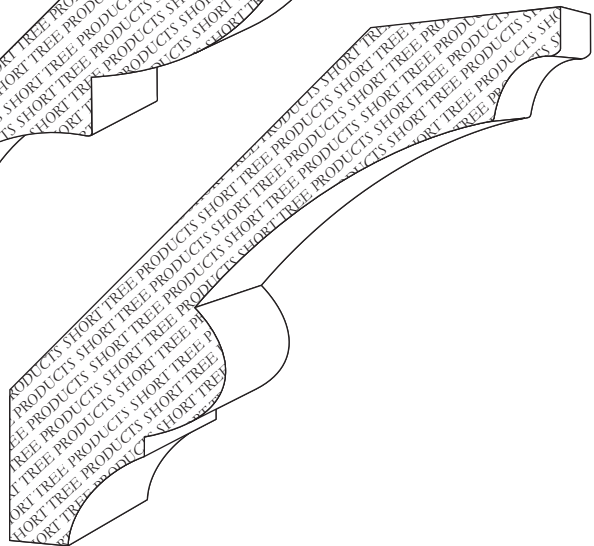

Ⓢ STOCKED OAK, POPLAR ONLY \* STOCKED OAK, POPLAR AND PINE

# CROWN MOULD

BLC 370  
13/16" x 3 5/8"

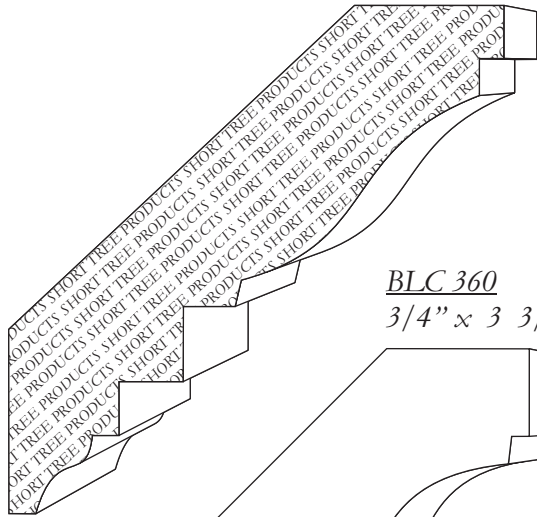

BLC-860  
13/16" x 7"

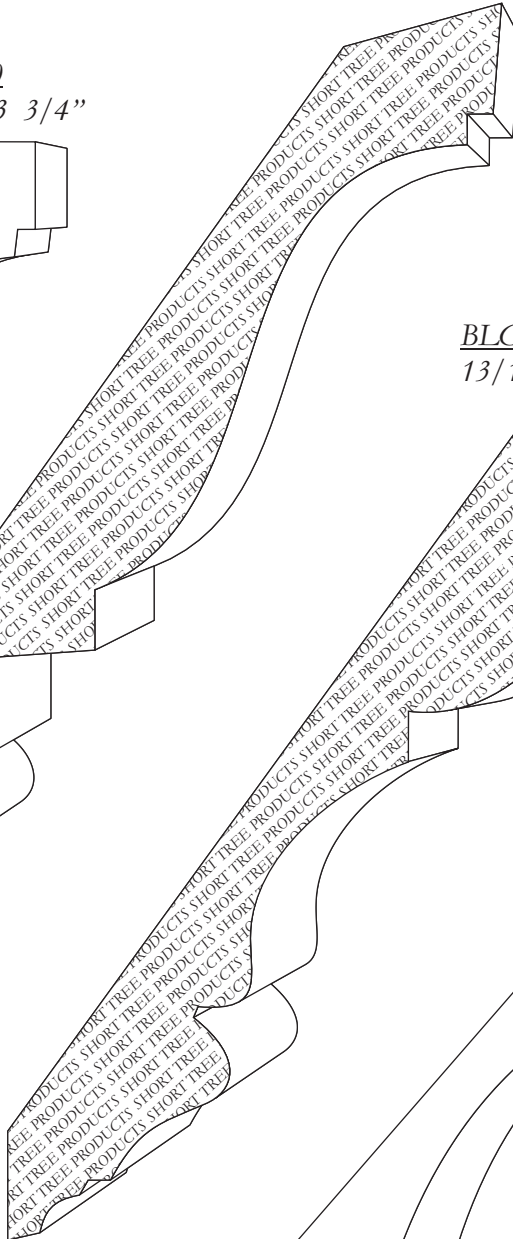

BLC 360  
3/4" x 3 3/4"

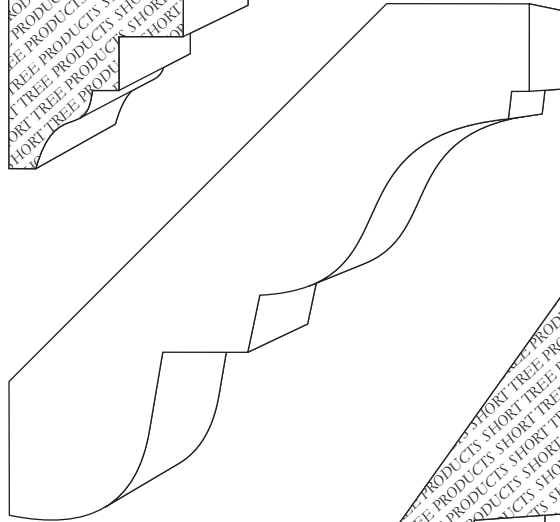

BLC-830  
13/16" x 5 1/2"

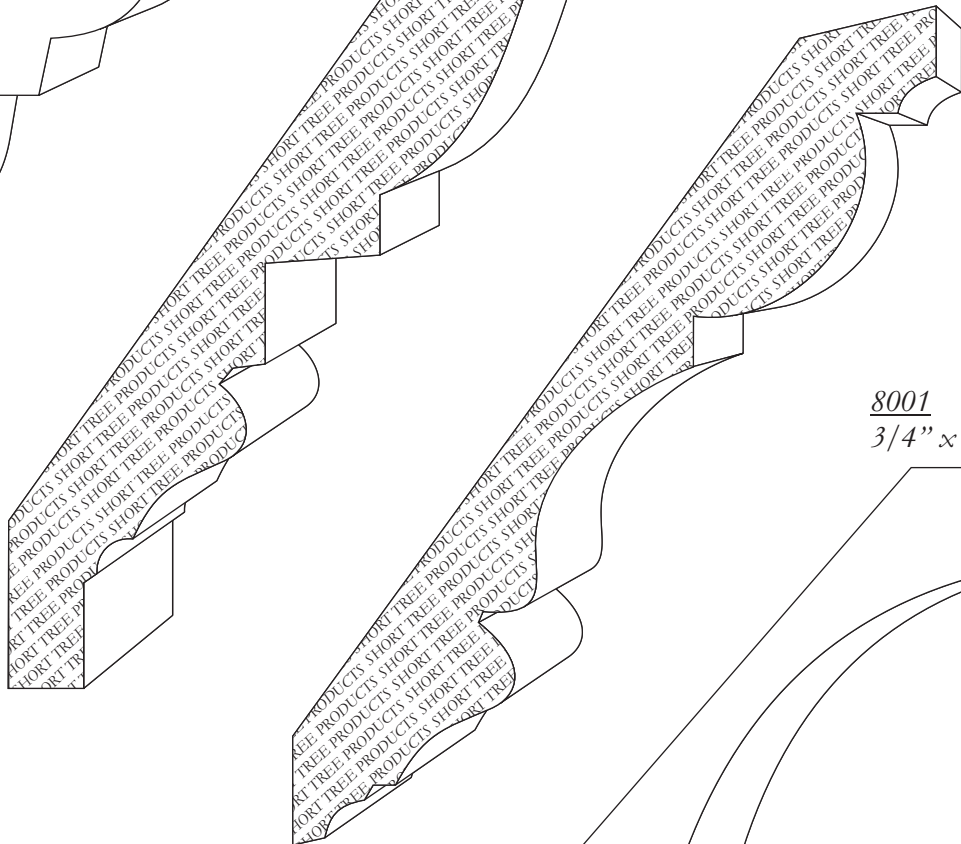

8001  
3/4" x 3 3/4"

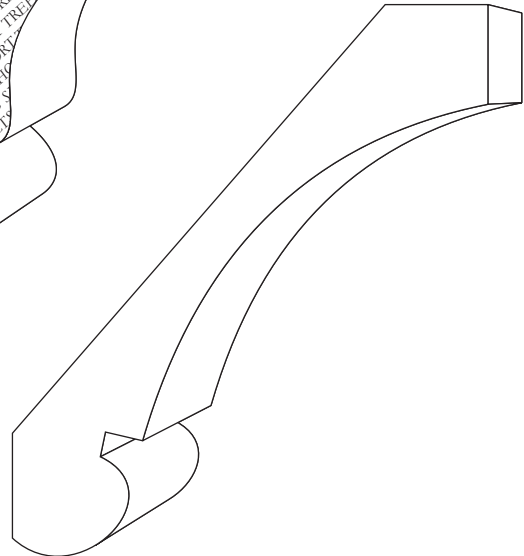



# DENTIL MOULD

BLC - 862  
13/16" x 7"  
WITH DENTIL

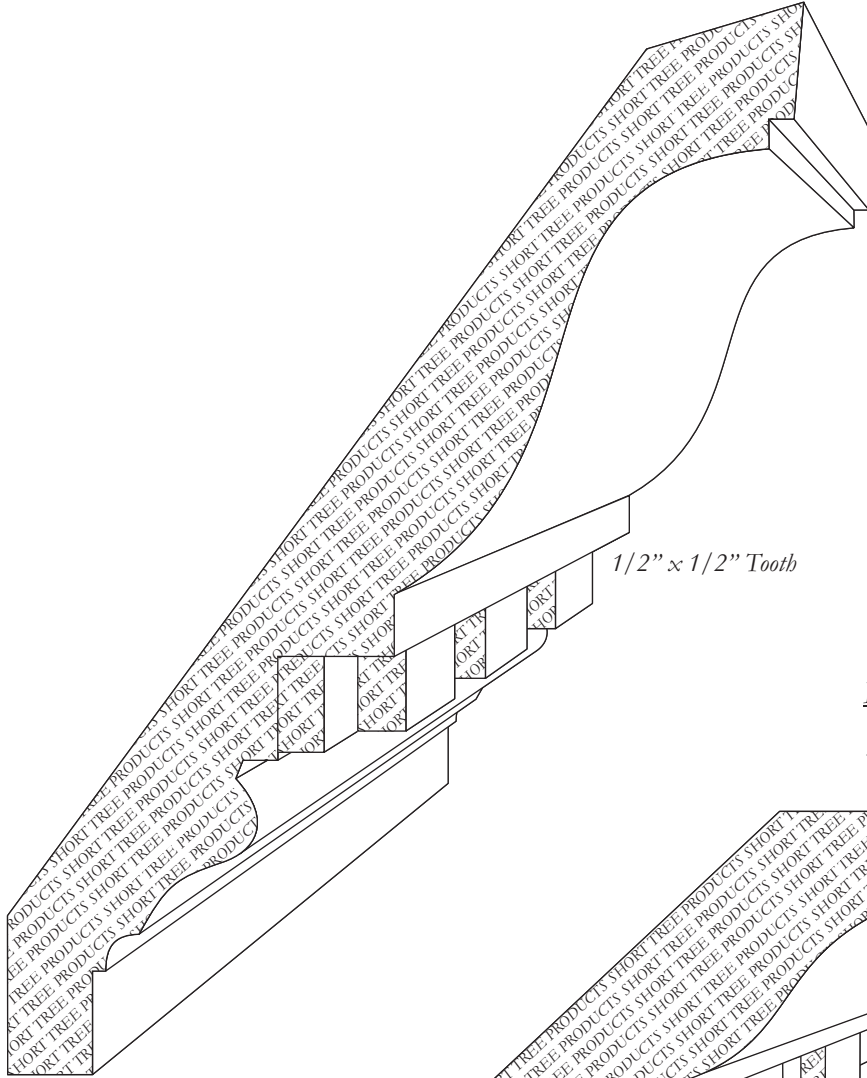

BLC 370D  
13/16" x 3 5/8"  
WITH DENTIL

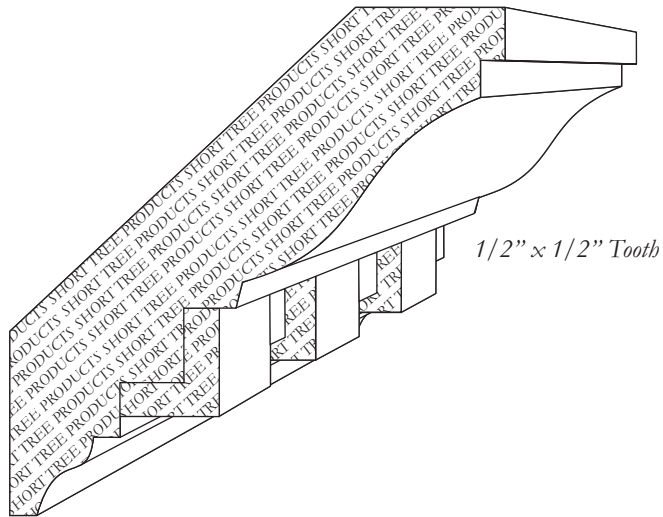

Ⓢ STOCKED OAK, POPLAR ONLY \* STOCKED OAK, POPLAR AND PINE

# DENTIL MOULD

D-1  
1/2" x 2"

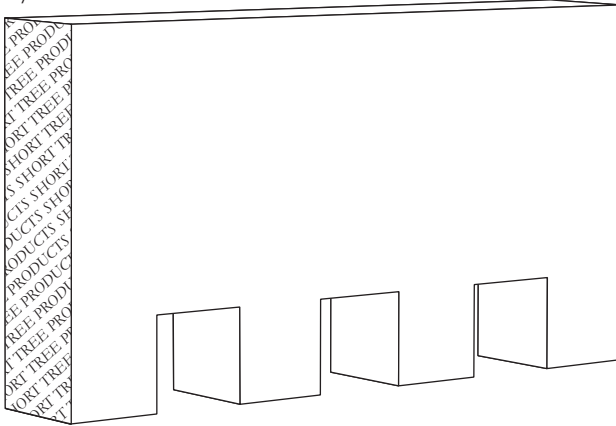

1/2" x 1/2" Tooth

BLC 353  
3/4" x 3 1/2"

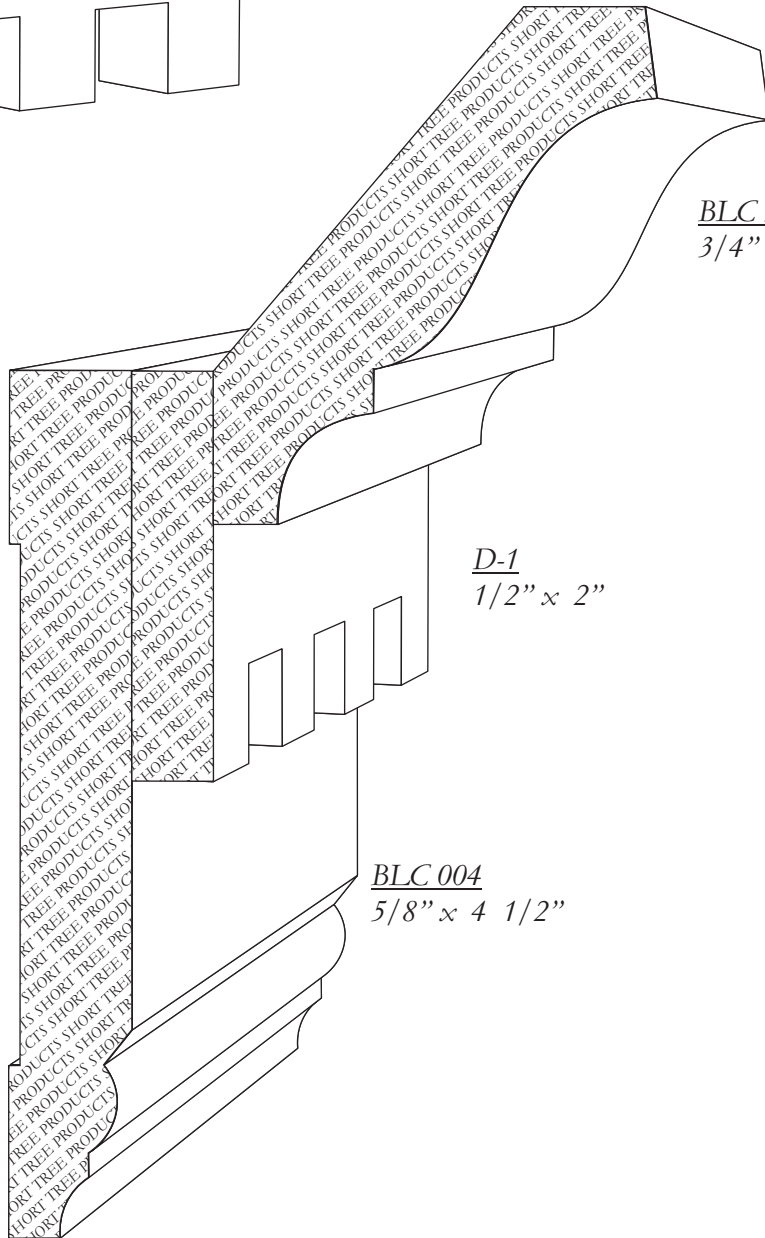

D-1  
1/2" x 2"

BLC 004  
5/8" x 4 1/2"



# BRICK MOULD

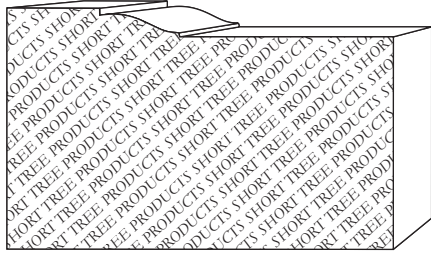

\*WP 180 1 1/4" x 2"

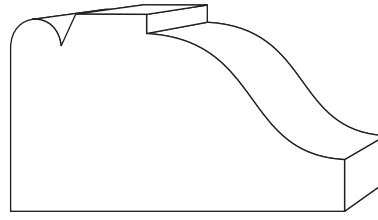

8148 1 1/16" x 1 3/4"

# T - ASTRAGAL

\*1 3/4" T-ASTRAGAL

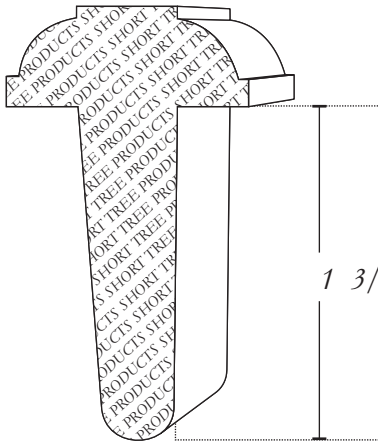

1 3/4" DOOR

\*1 3/8" T-ASTRAGAL

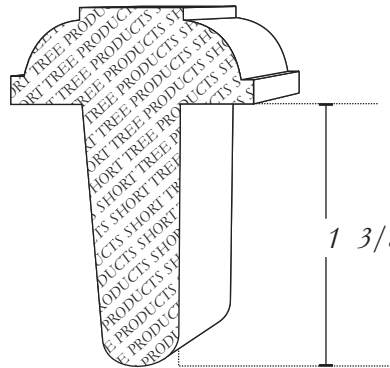

1 3/8" DOOR

# WINDOW & DOOR STOP

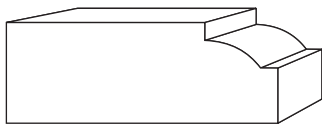

BLC 704 1/2" x 1 3/8"



BLC 703 1/2" x 1 3/8"

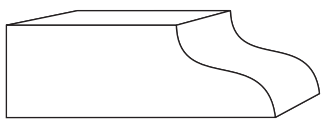

8095 1/2" x 1 3/8"

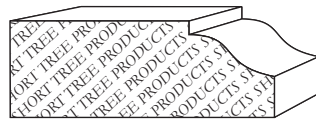

BLC 705 1/2" x 1 3/8"

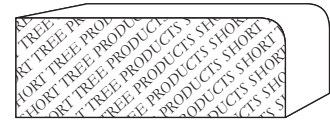

BLC 702 1/2" x 1 3/8"



# CORNER MOULD

WM 206

3/4" x 3/4"

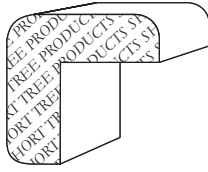

BLC 1004

1 1/16" x 1 1/16"

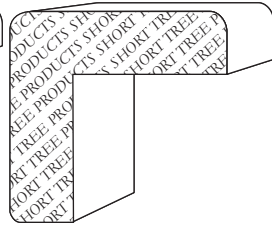

8238

1 3/8" x 1 3/8"

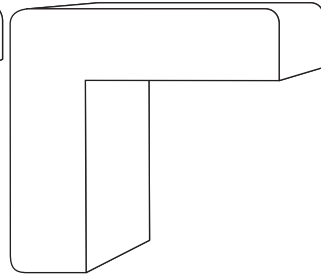

8202

1 1/8" x 1 1/8"

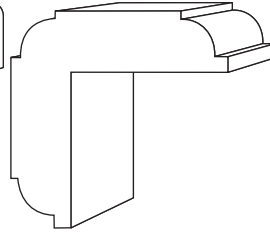

8201

1 3/8" x 1 3/8"

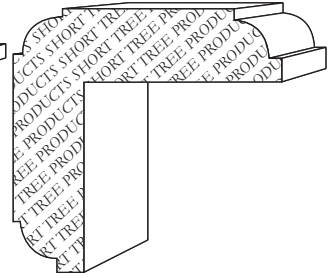

# SHELF CLEATS

8205

3/4" x 1 3/4"

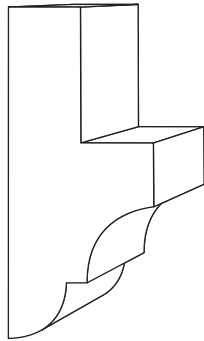

8204

3/4" x 1 3/4"

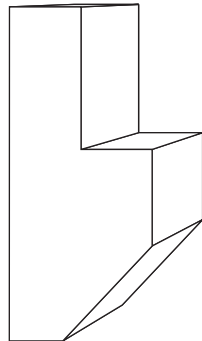

8203

3/4" x 1 3/4"

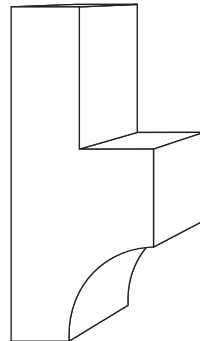

8242

3/4" x 1 7/8"

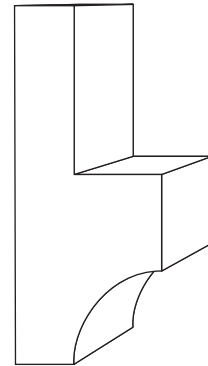

# MIRROR MOULD

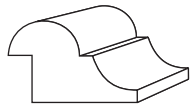

8919 7/16" x 1 1/16"

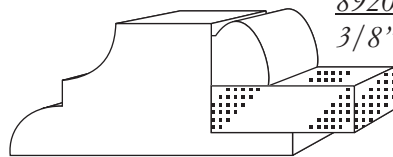

8917 1 1/16" x 1 1/2"

8920

3/8" x 5/16"

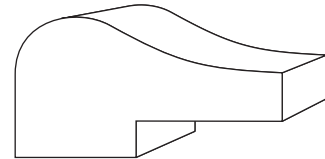

8918 3/4" x 1 3/8"

# THRESHOLD

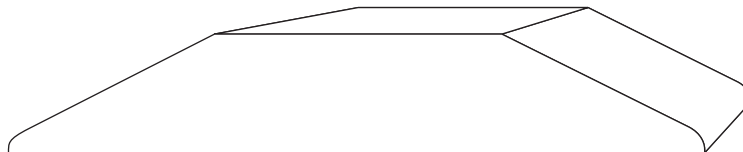

8278 5/8" x 3 5/8"

© STOCKED OAK, POPLAR ONLY \* STOCKED OAK, POPLAR AND PINE



# WINDOW STOOLS

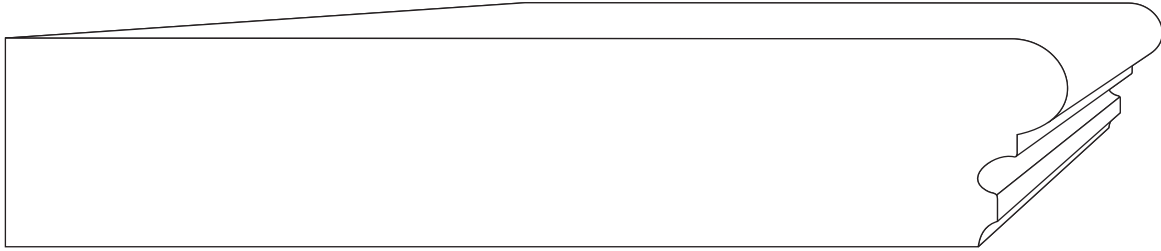

BLC A-1

1 1/16" x 3 1/2"

1 1/16" x 5 1/2"

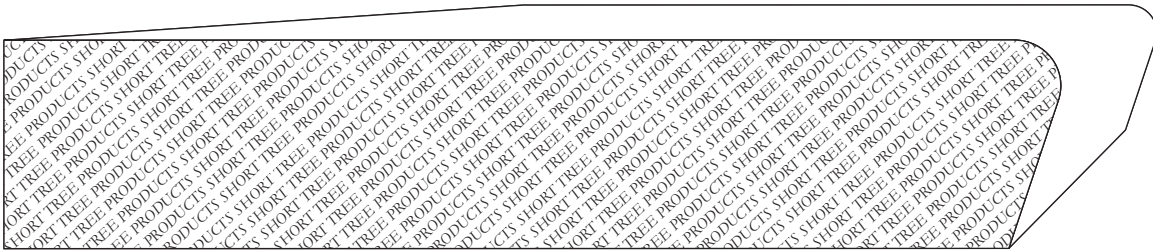

\*BLC A-2

1 1/16" x 3 1/2"

1 1/16" x 5 1/2"

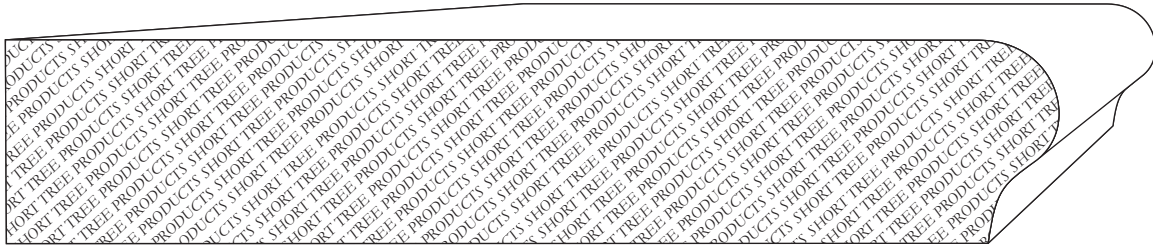

\*BLC A-3

1 1/16" x 3 1/2"

1 1/16" x 5 1/2"



# PLYNTH BLOCKS

P-6

1 1/16" x 4 1/2" x 8"

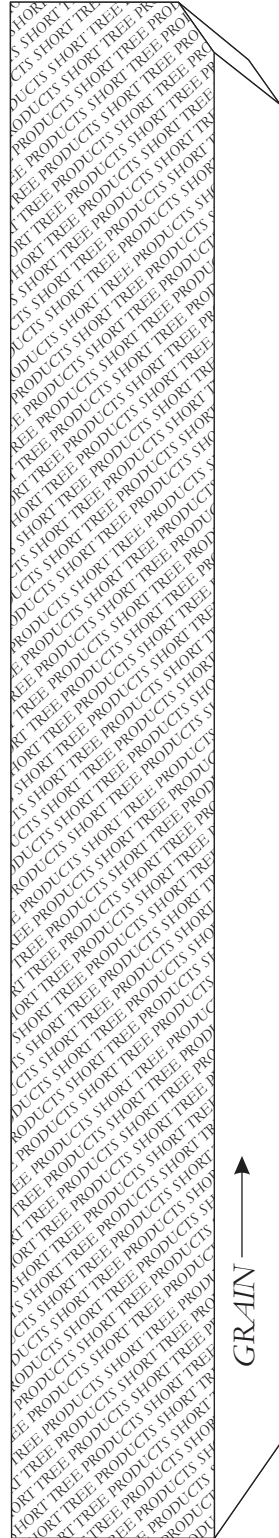

P-2

1 1/16" x 4 1/2" x 8"

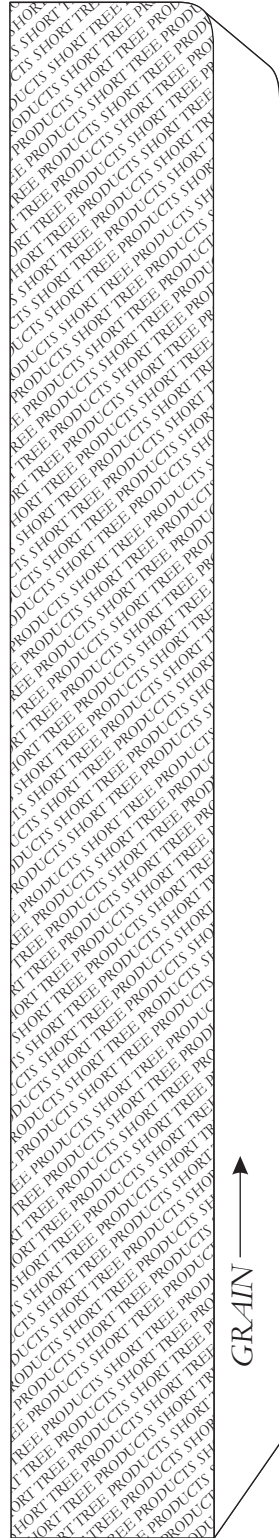

P-3

1 1/16" x 4 1/2" x 8"

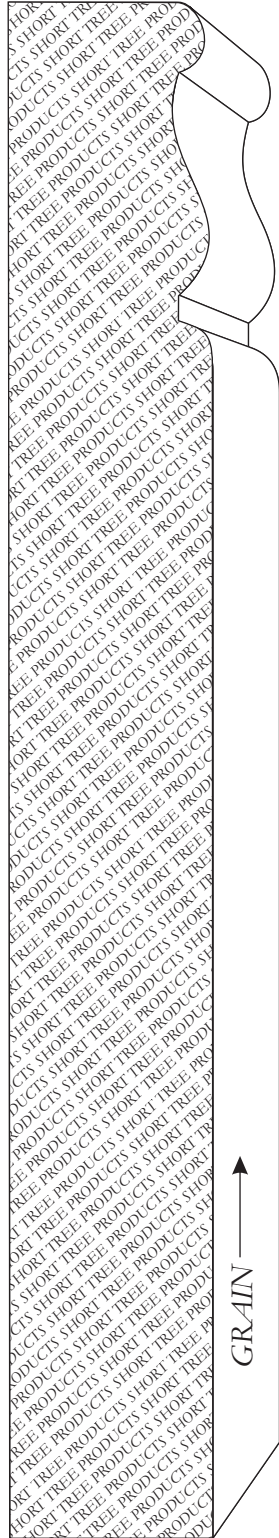

P-5

1 1/16" x 7 1/8" x 4 1/2"

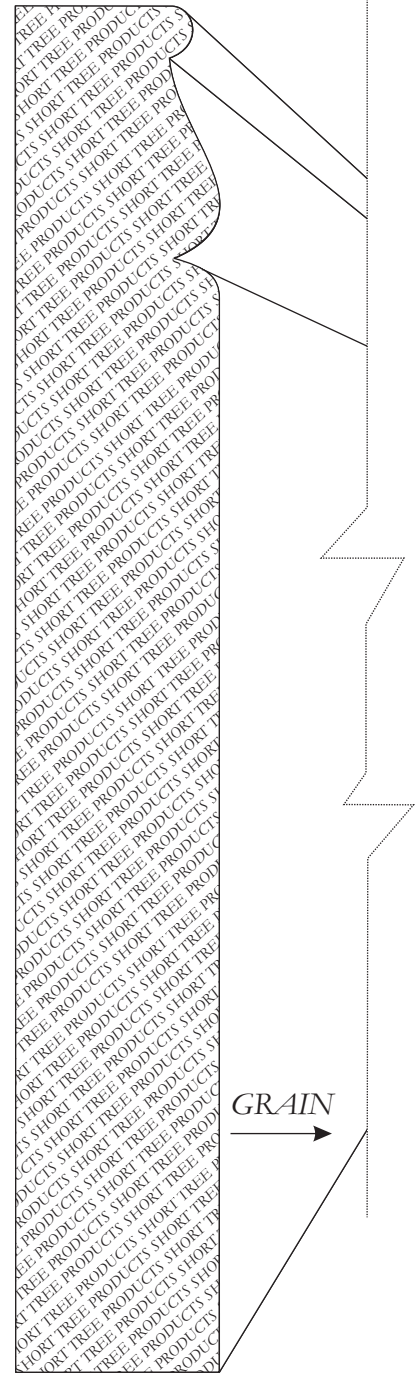

© STOCKED OAK, POPLAR ONLY \* STOCKED OAK, POPLAR AND PINE



# ROSETTES

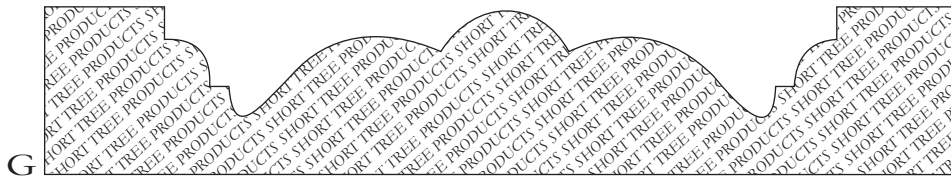
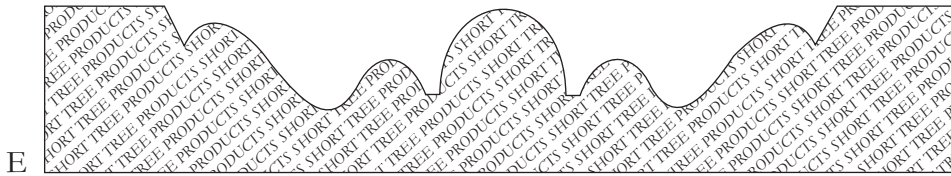
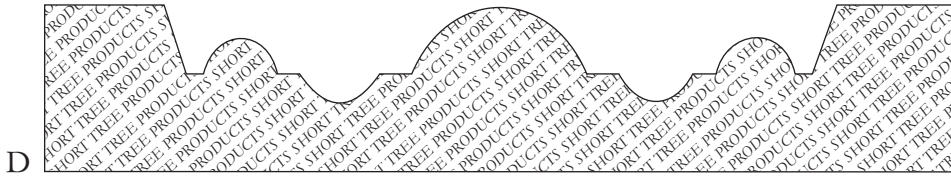
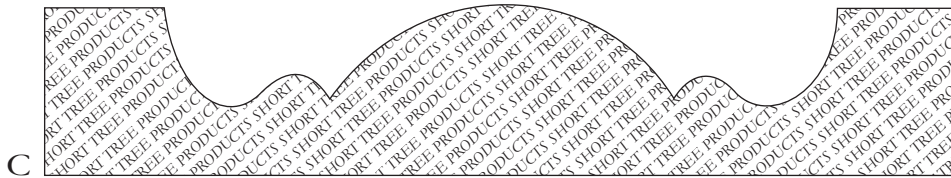
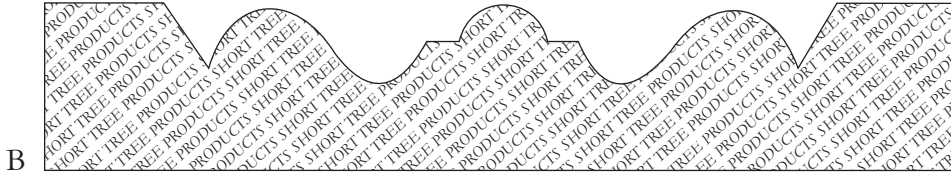
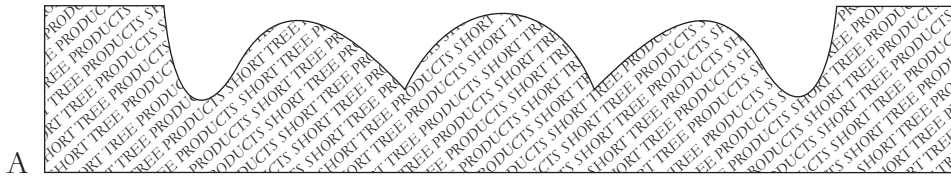

## STOCK SIZES

$7/8'' \times 2 \ 3/4'' \times 2 \ 3/4''$

$7/8'' \times 3 \ 3/4'' \times 3 \ 3/4''$

$7/8'' \times 4 \ 3/4'' \times 4 \ 3/4''$

*All the patterns in each of the stock sizes may be trimmed up to 3/4''*



# RADIUS AND ARCH TRIM

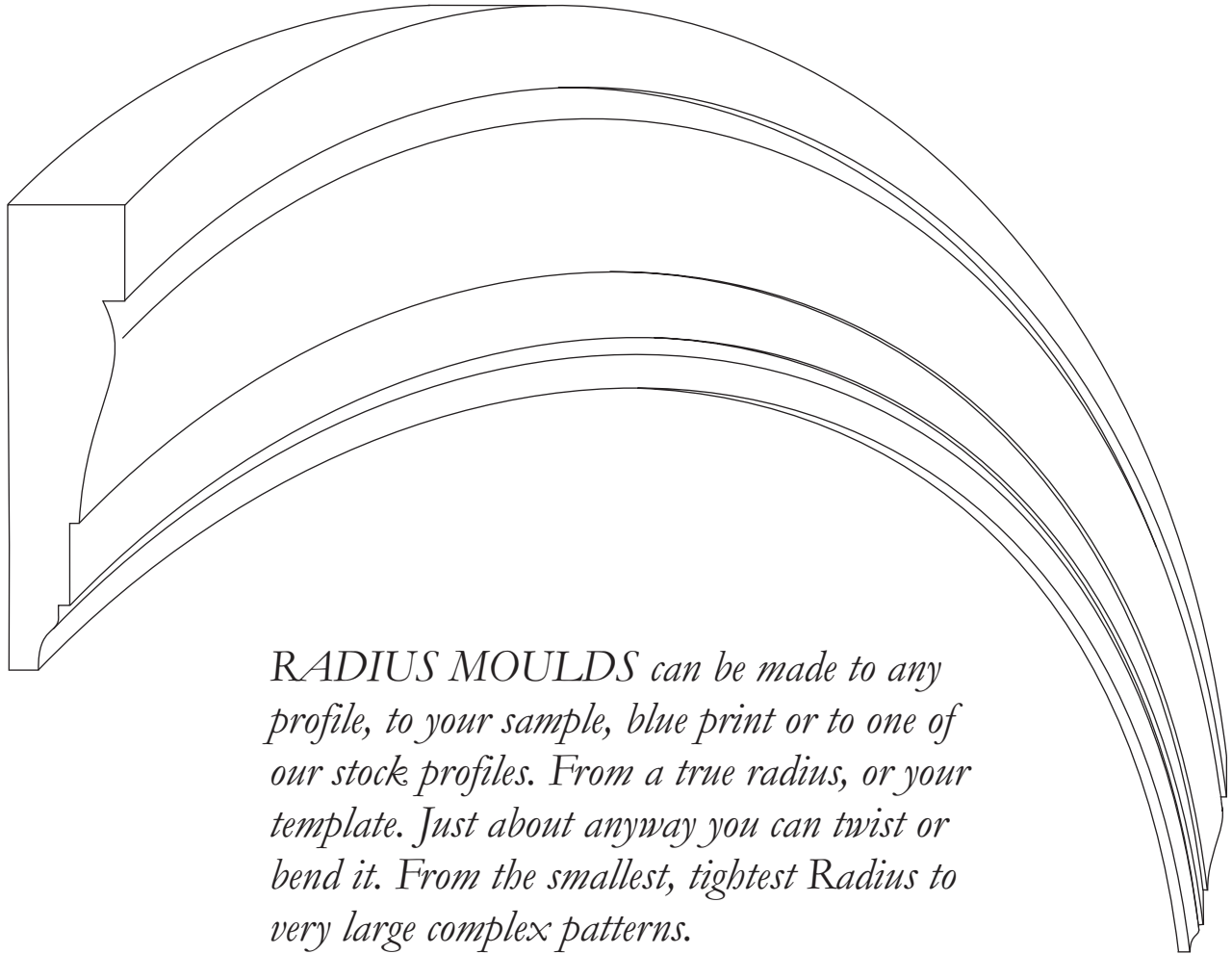

*RADIUS MOULDS can be made to any profile, to your sample, blue print or to one of our stock profiles. From a true radius, or your template. Just about anyway you can twist or bend it. From the smallest, tightest Radius to very large complex patterns.*



# HAND RAIL

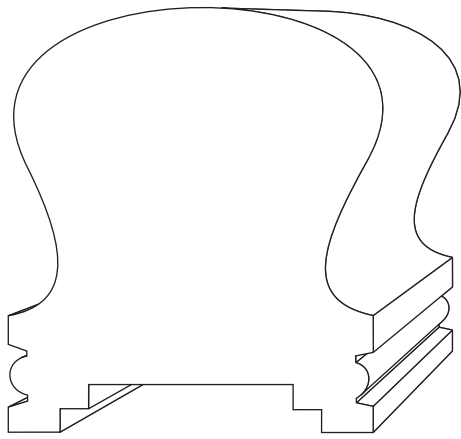

8829 1 7/8" x 2 1/4"

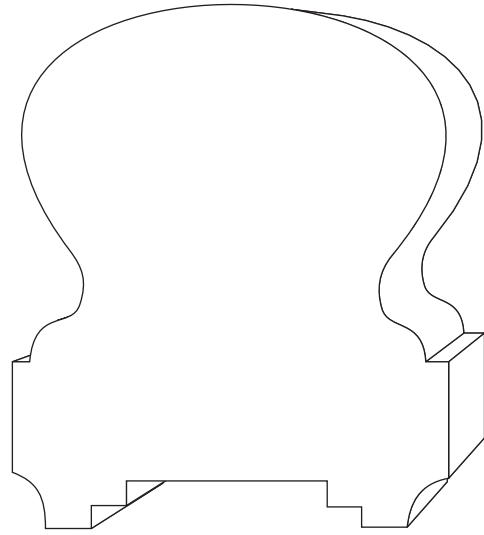

8830 2 1/4" x 2 3/4"

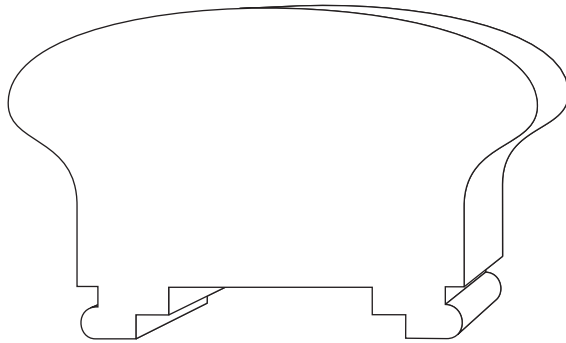

8831 1 3/4" x 2 3/4"

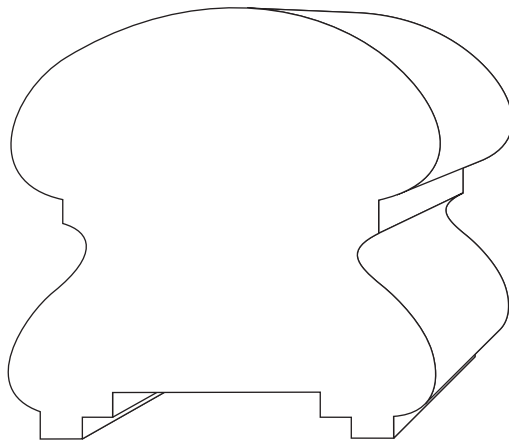

8832 2 1/4" x 2 1/4"

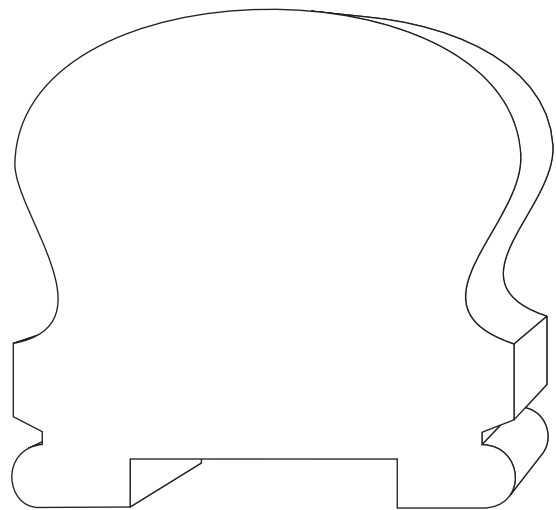

8833 2 5/8" x 2 5/8"



Ⓢ STOCKED OAK, POPLAR ONLY \*STOCKED OAK, POPLAR AND PINE

# HAND RAIL

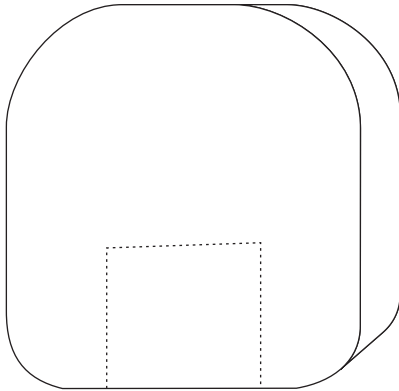

BLC455 2" x 1 13/16"

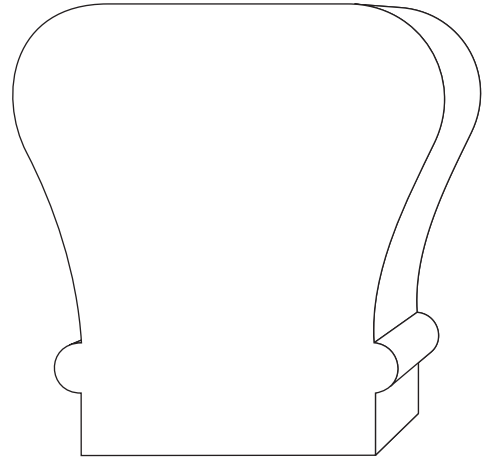

BLC458 2 3/8" x 2 1/4"

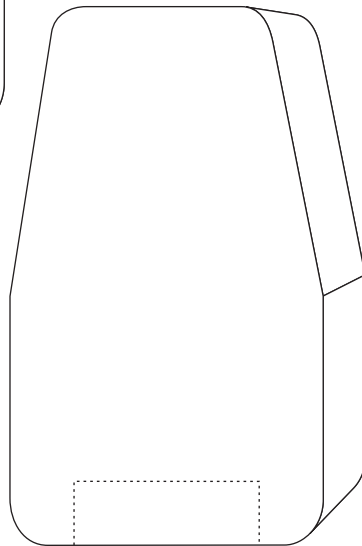

BLC457 2 3/4" x 1 5/8"

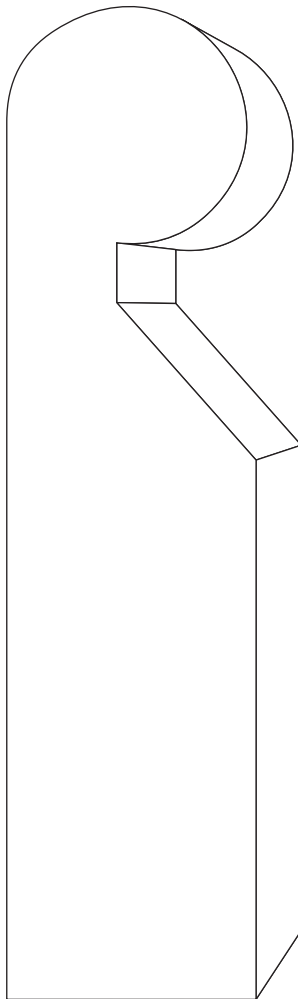

BLC460 5 1/4" x 1 1/4"

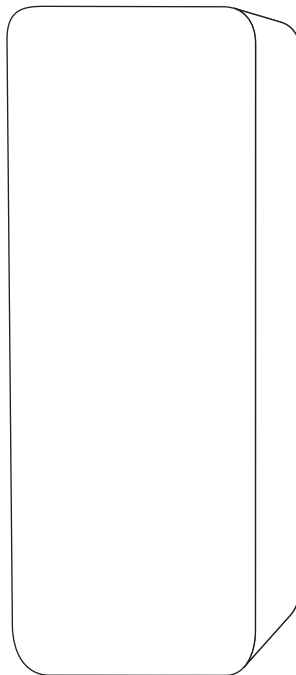

BLC459 3 1/2" x 1 1/4"

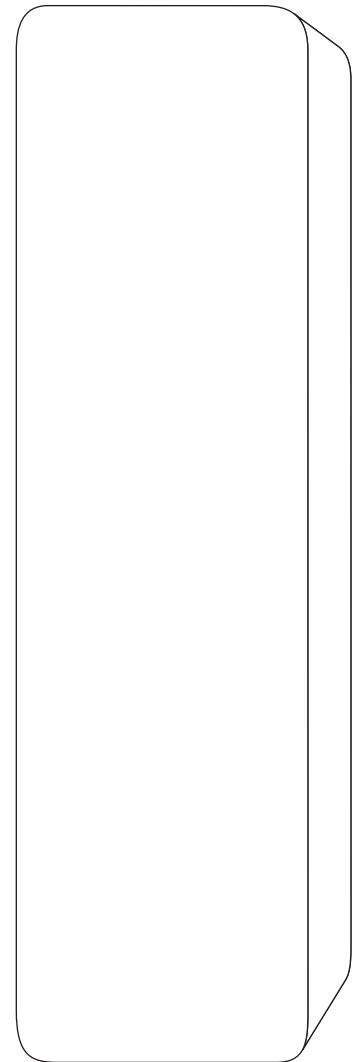

BLC451 5 1/2" x 1 1/2"



# HAND RAIL

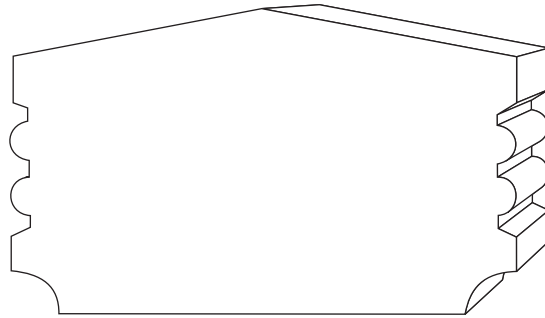

8834 1 5/8" x 2 5/8"  
1 5/8" x 3 5/8"

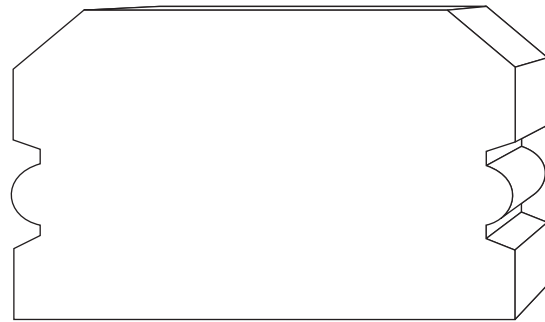

8835 1 5/8" x 3 5/8"  
1 5/8" x 2 5/8"

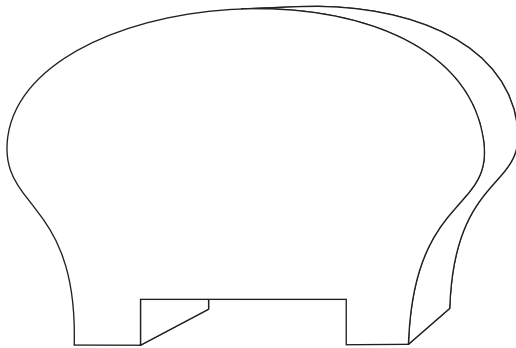

8839 1 3/4" x 2 1/2"

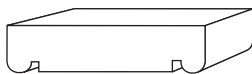

8848 1/4" x 1 1/16"

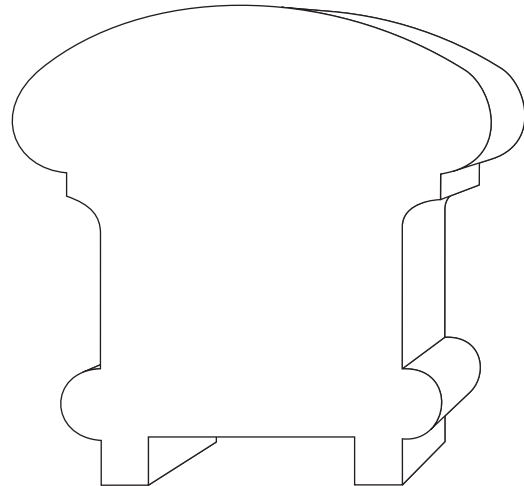

8836 2 1/2" x 2 1/2"



# HAND RAIL

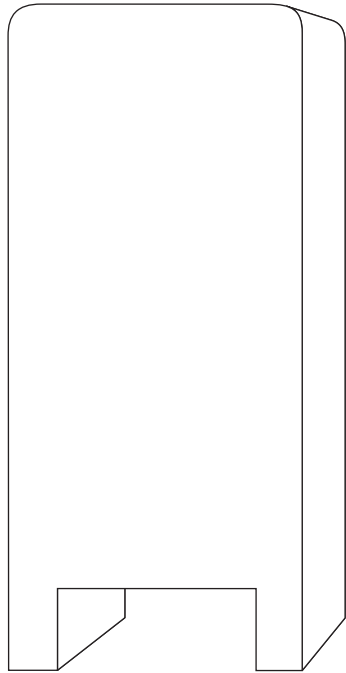

BLC 462 1 1/2" x 3 1/2"

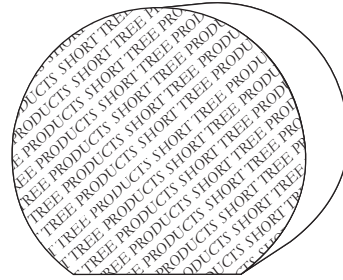

BLC 461 1 3/8" x 1 1/2"

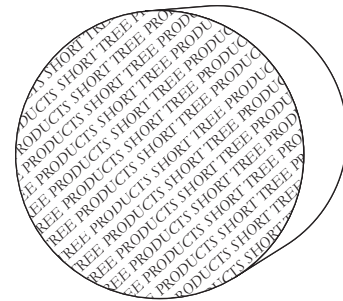

DOWEL 1 1/2" Diameter

# BAR RAIL

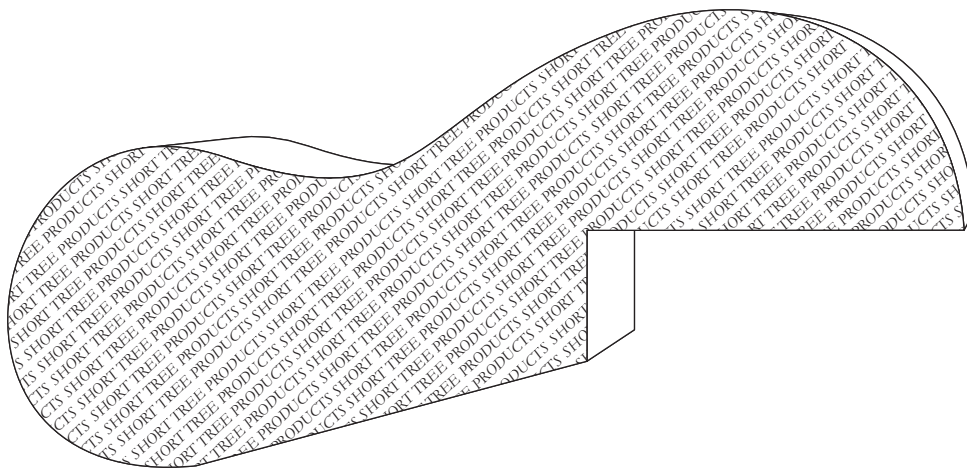

BLC 501 1 5/8" x 5"



# SQUARES

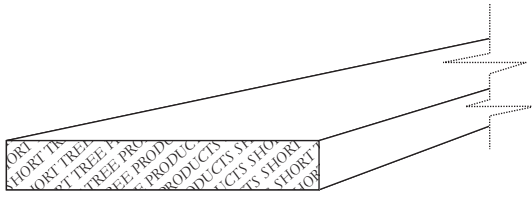

**LATTICE**  
1/4" x 1 3/8"

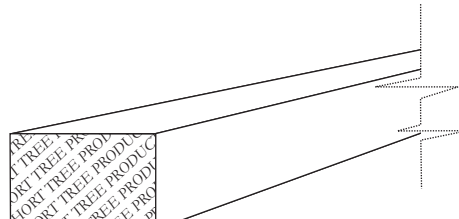

1/2" x 3/4"

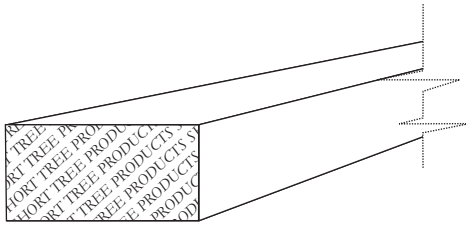

1/2" x 1"

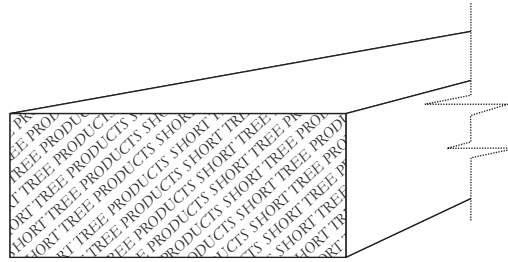

**CABINET FACING**  
3/4" x 1 3/4"

# S4S

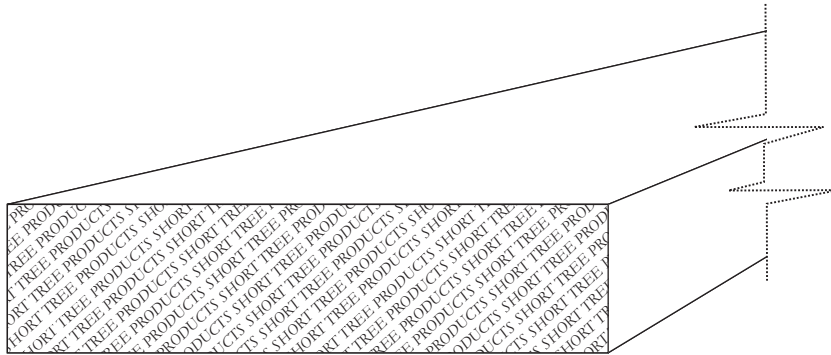

**S4S C/BETTER, SURFACED 4 SIDES  
CLEAR/FACE, 2 EDGES**

STOCKED IN POPLAR AND RED OAK

STOCK SIZE	S4S NET SIZE	LENGTHS
1" x 2"	3/4" x 1 1/2"	2' - 16'
1" x 4"	3/4" x 3 1/2"	2' - 16'
1" x 6"	3/4" x 5 1/2"	2' - 16'
1" x 8"	3/4" x 7 1/4"	2' - 16'
1" x 10"	3/4" x 9 1/4"	2' - 16'
1" x 12"	3/4" x 11 1/4"	2' - 16'

OTHER SPECIES AND CUSTOM SIZES AVAILABLE



Ⓢ STOCKED OAK, POPLAR ONLY \* STOCKED OAK, POPLAR AND PINE

# BEADED WAINSCOTING



\*BEADED WAINSCOTING  
3/8" x 4 1/8" FACE

\*BLC 258

11/16" x 7/8"

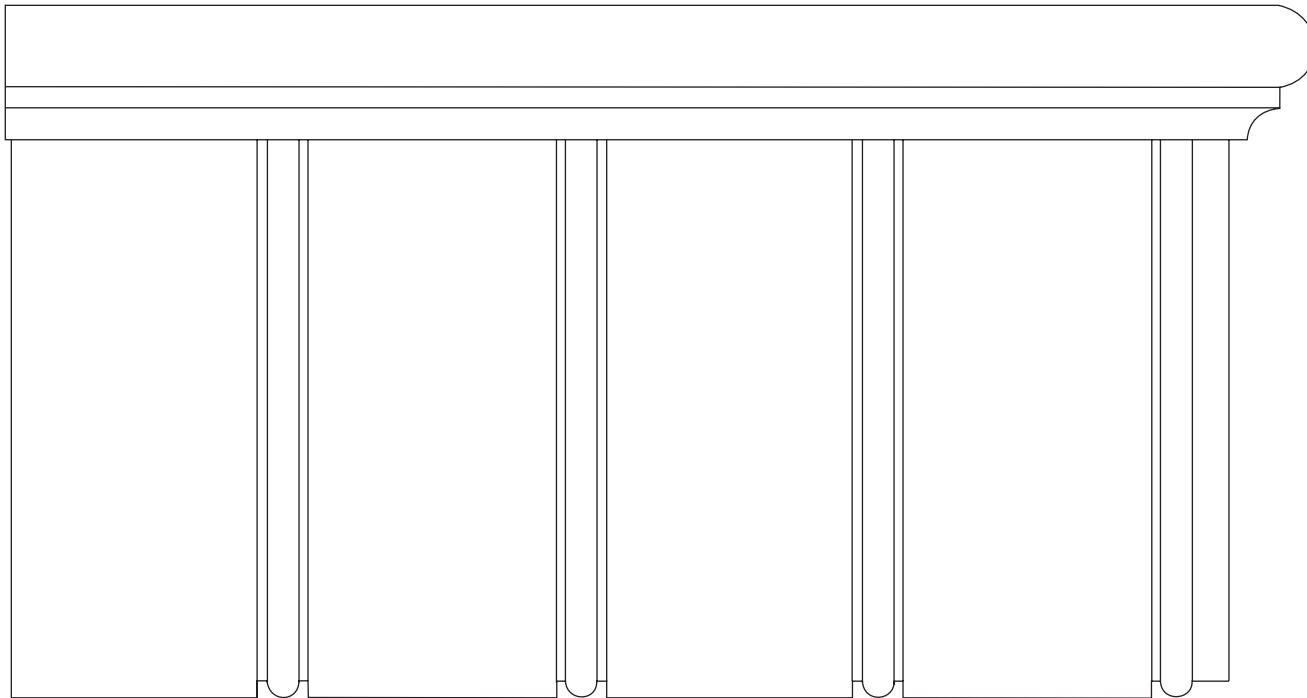

# WOOD PANELING

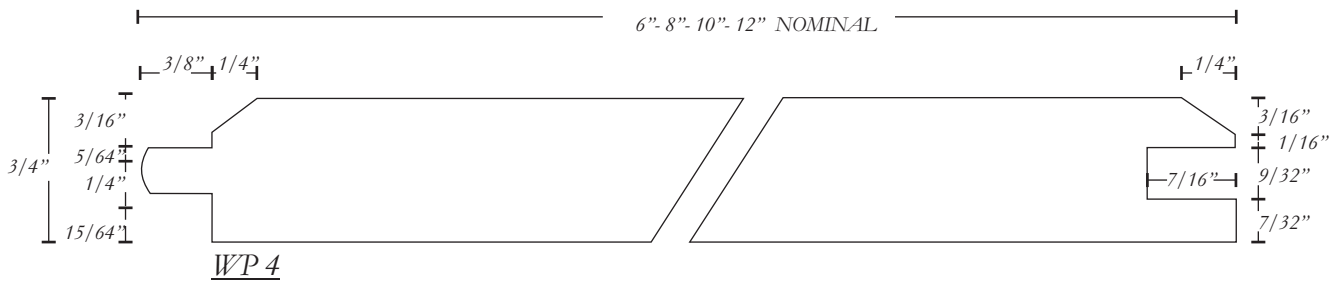
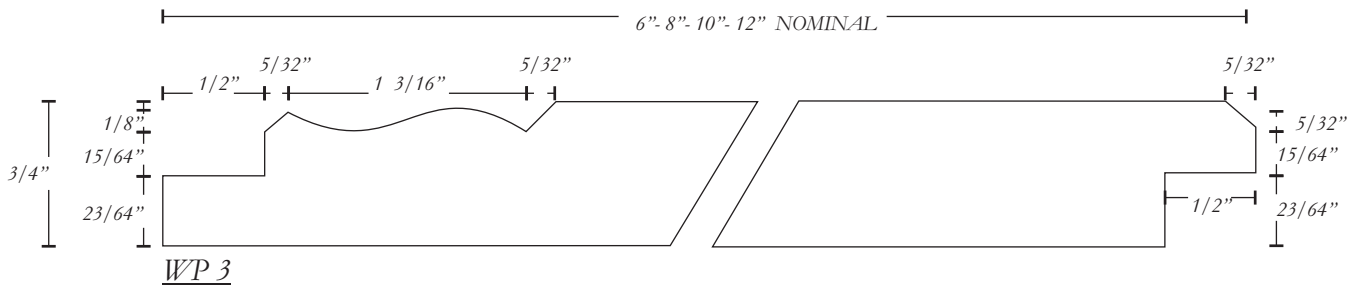
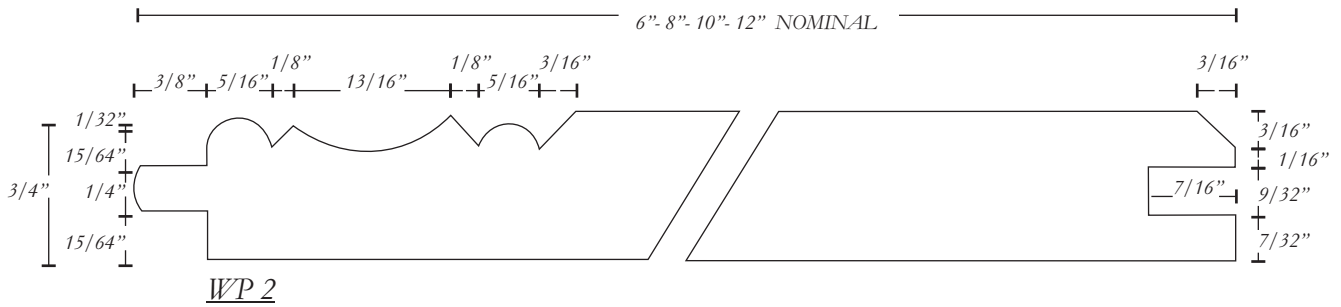
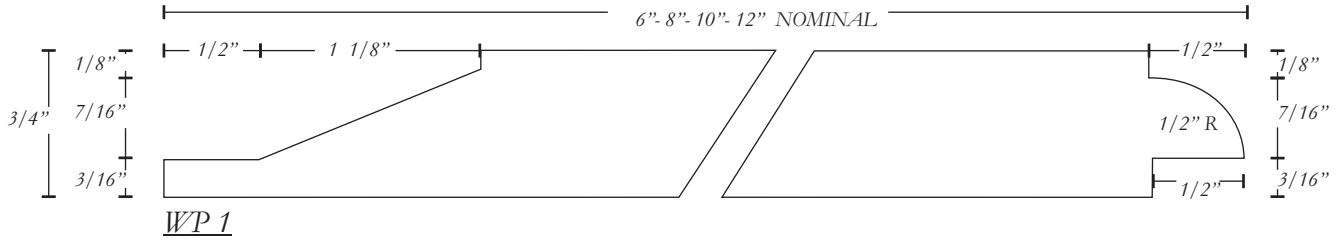

Ⓢ STOCKED OAK, POPLAR ONLY \*STOCKED OAK, POPLAR AND PINE

# WOOD PANELING

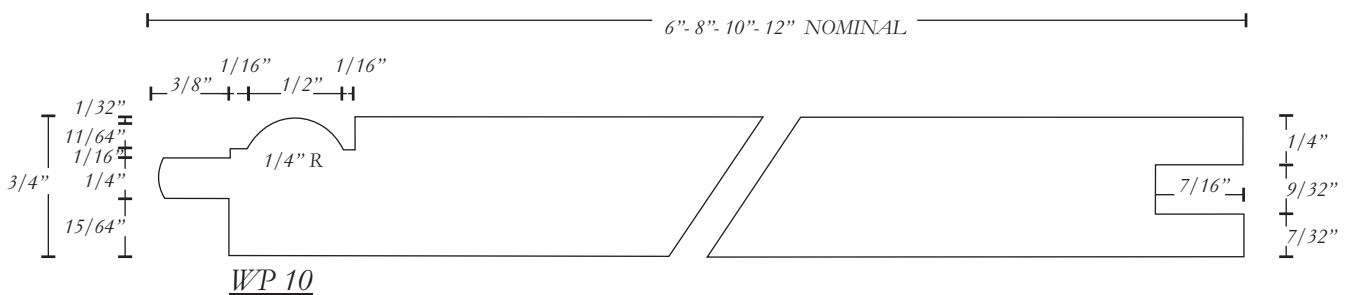
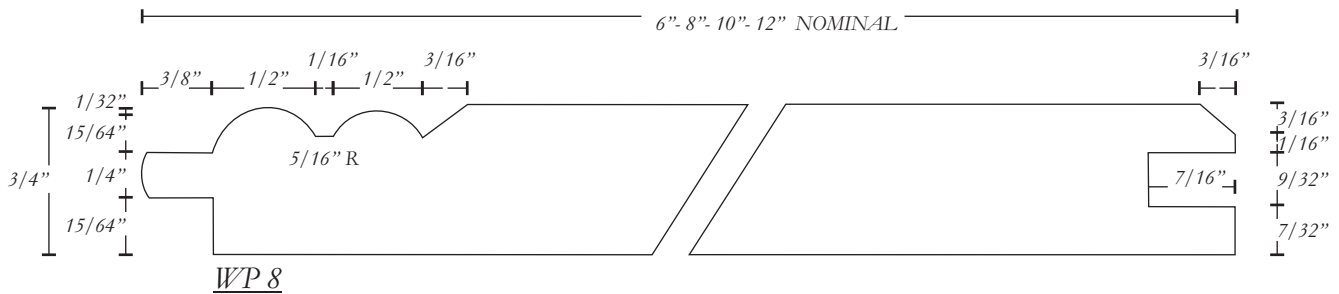
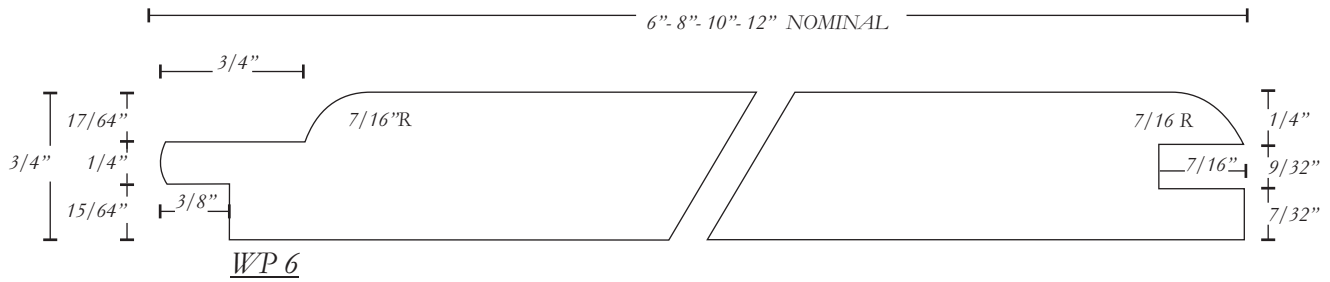
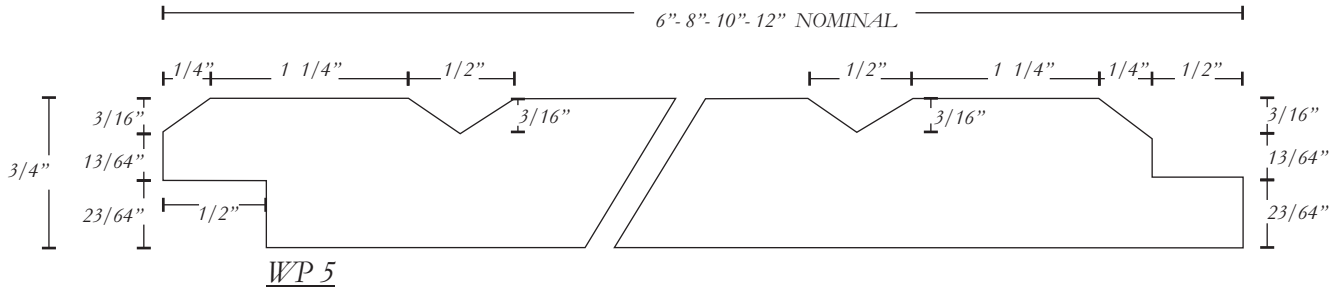

Ⓢ STOCKED OAK, POPLAR ONLY \*STOCKED OAK, POPLAR AND PINE





# WOOD PANELING

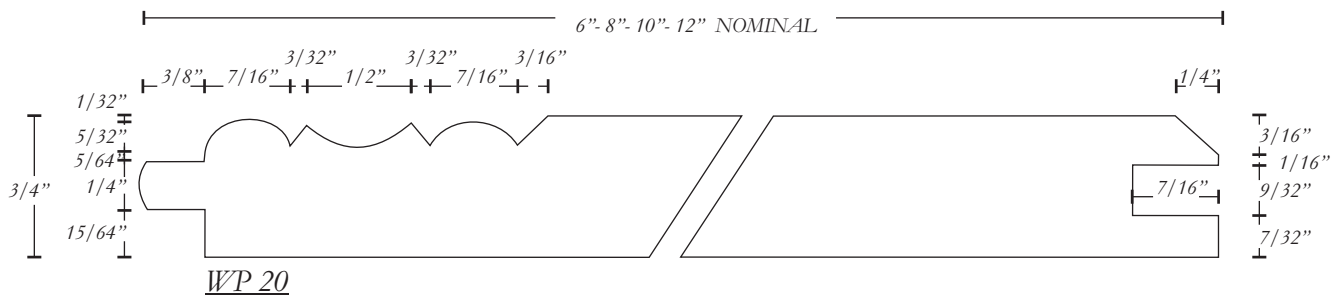
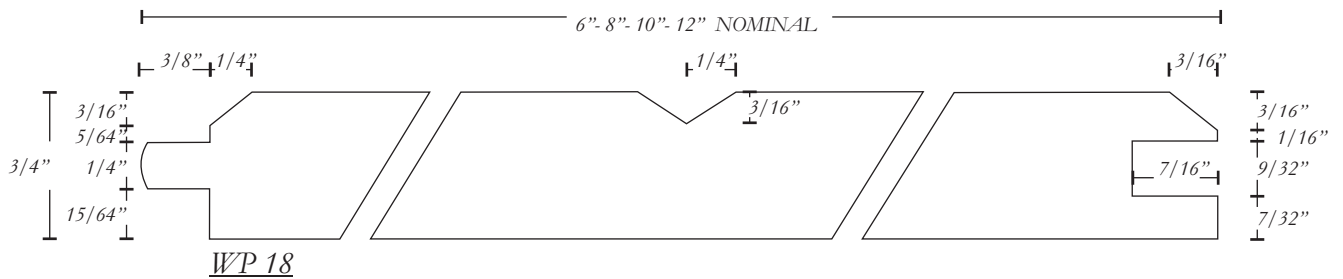
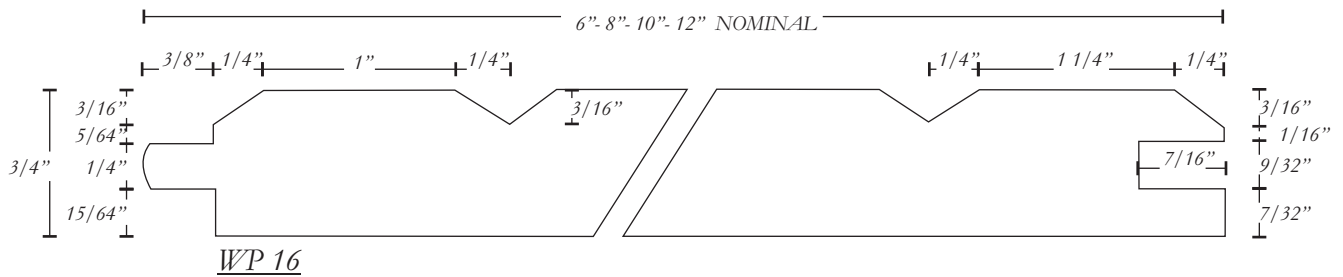
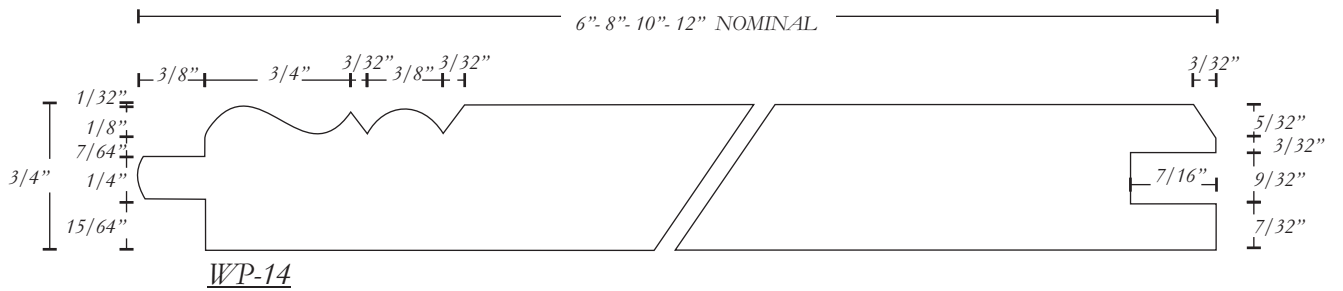
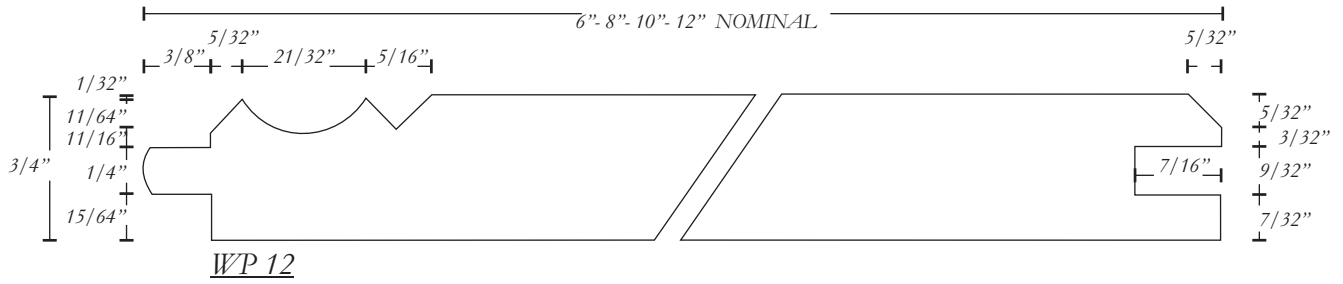

STOCKED OAK, POPLAR ONLY \*STOCKED OAK, POPLAR AND PINE

# CEILING & PARTITION

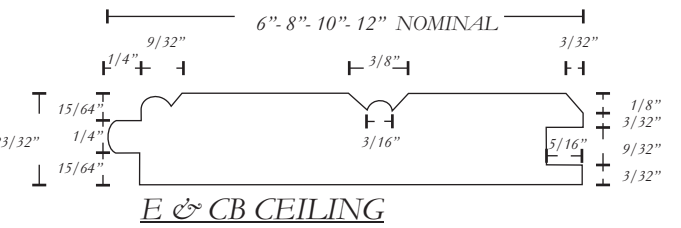
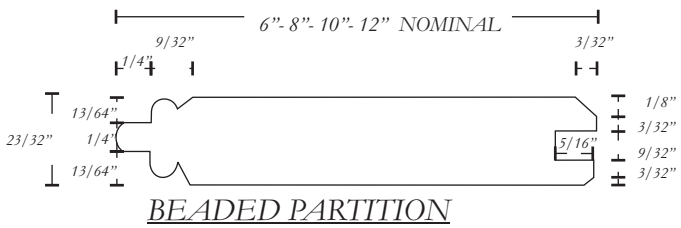
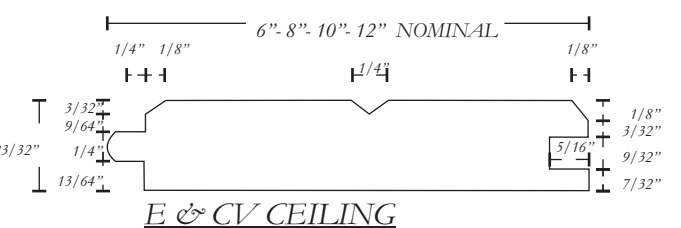
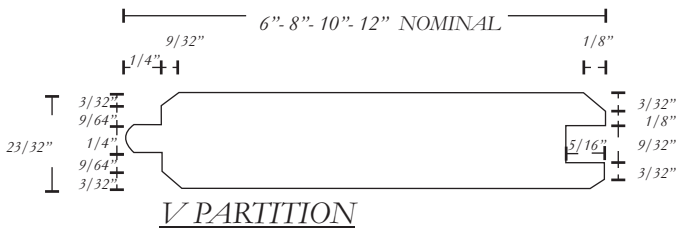
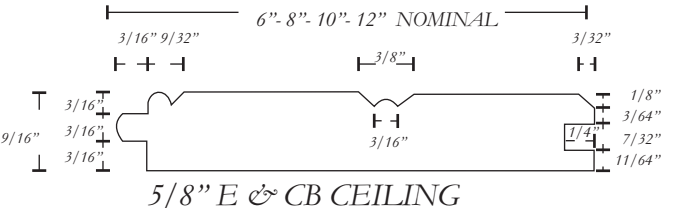
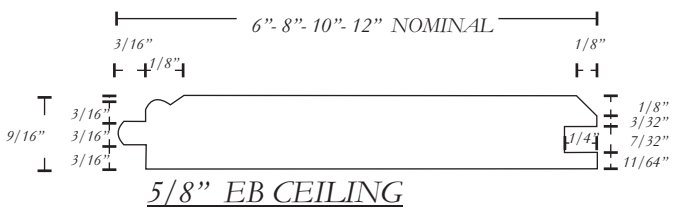
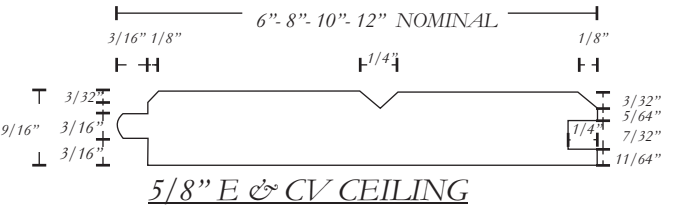
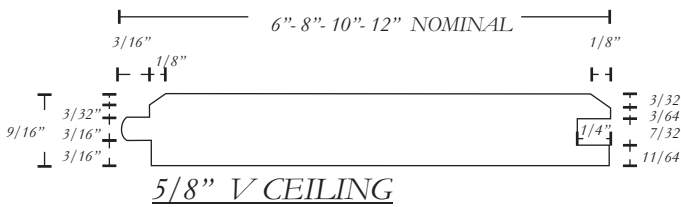
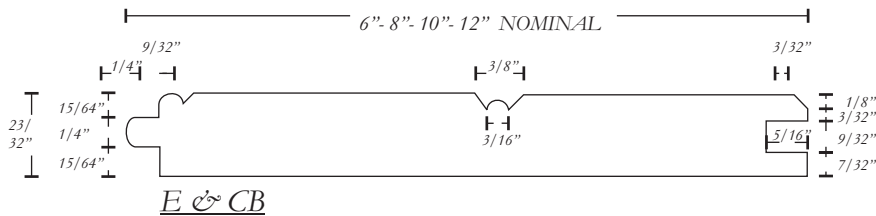
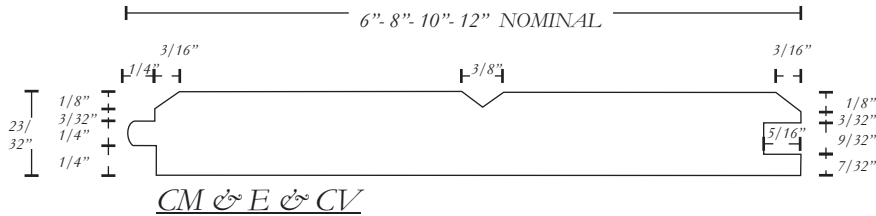
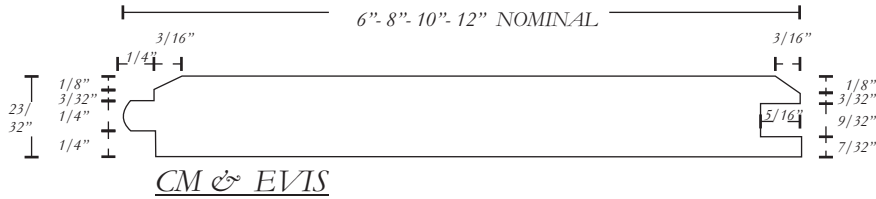

STOCKED OAK, POPLAR ONLY \* STOCKED OAK, POPLAR AND PINE



# WOOD SIDING

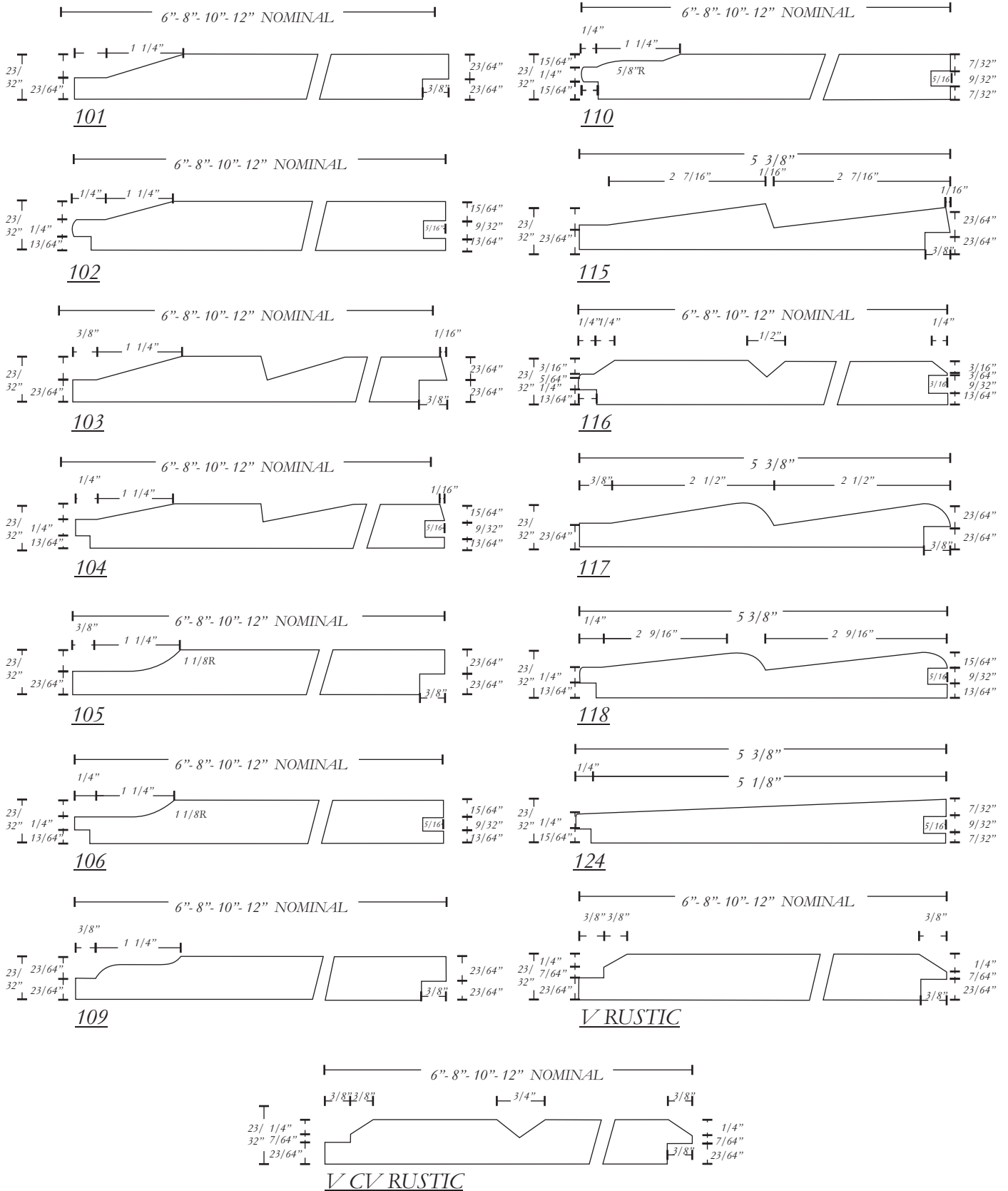

⊗ STOCKED OAK, POPLAR ONLY \* STOCKED OAK, POPLAR AND PINE

# WOOD SIDING

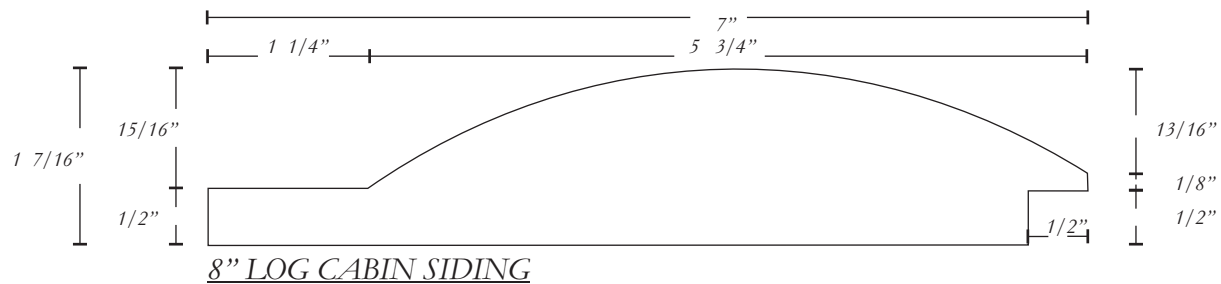
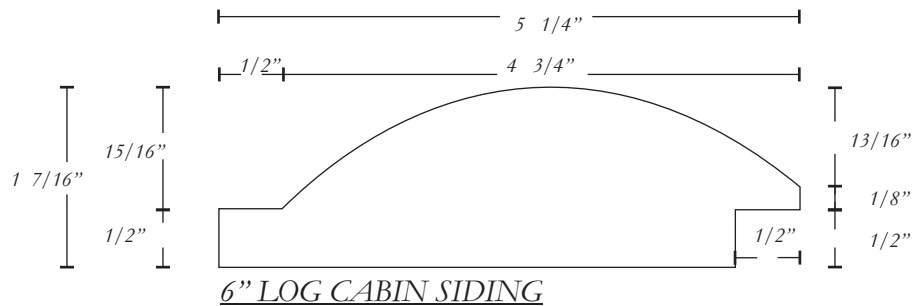
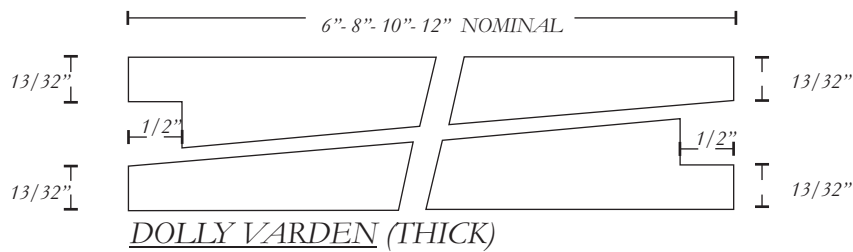
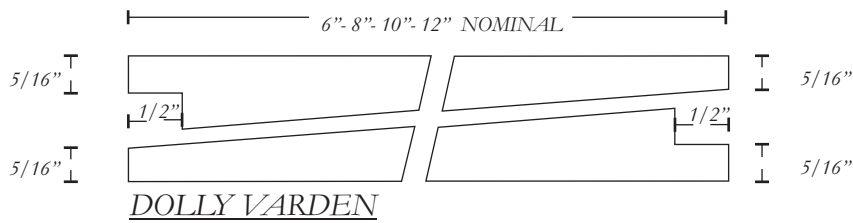
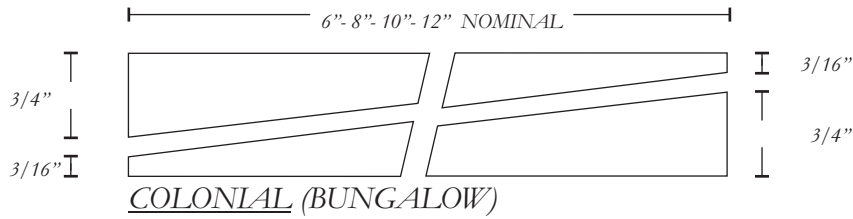
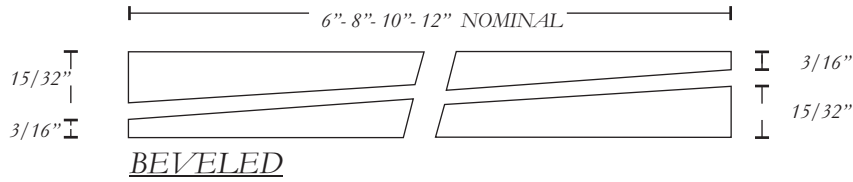

Ⓢ STOCKED OAK, POPLAR ONLY \* STOCKED OAK, POPLAR AND PINE



# INLAND RUSTIC SIDING

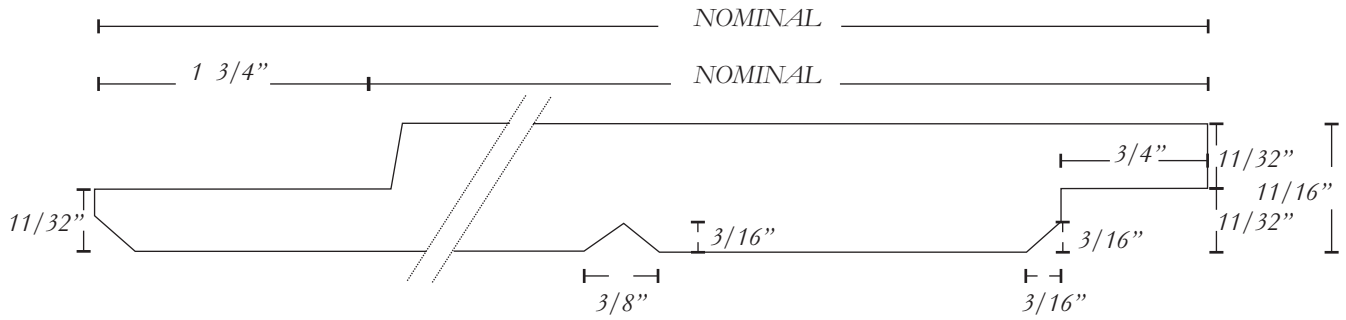

# FLOORING

## SQUARE EDGE FLOORING

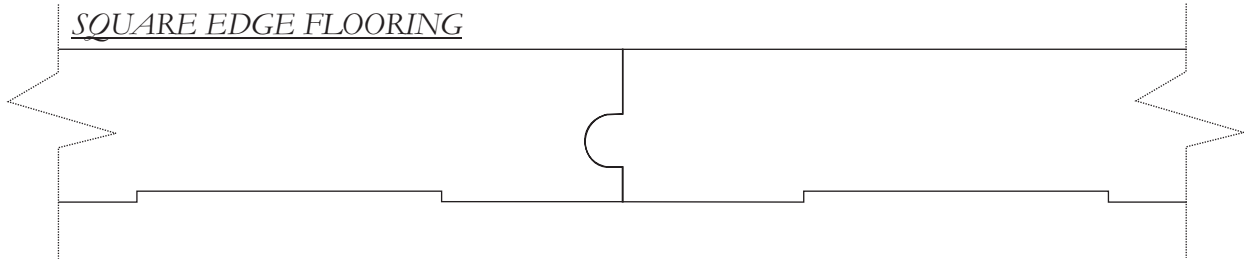

## COLONIAL PLANK FLOORING 1/16" VEE

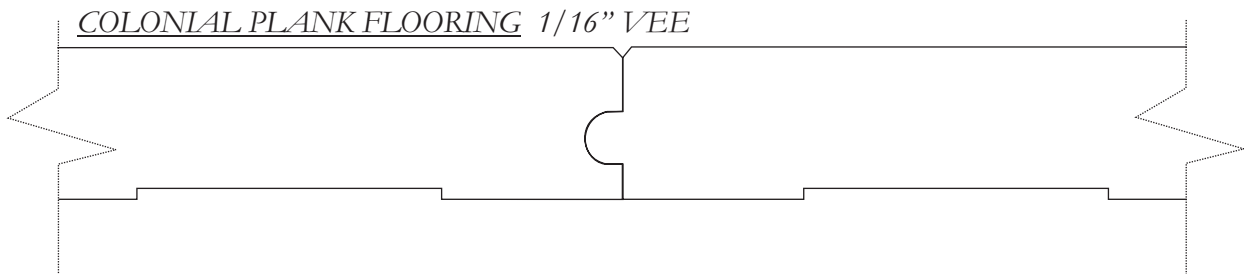

## COLONIAL PLANK FLOORING 1/32" VEE

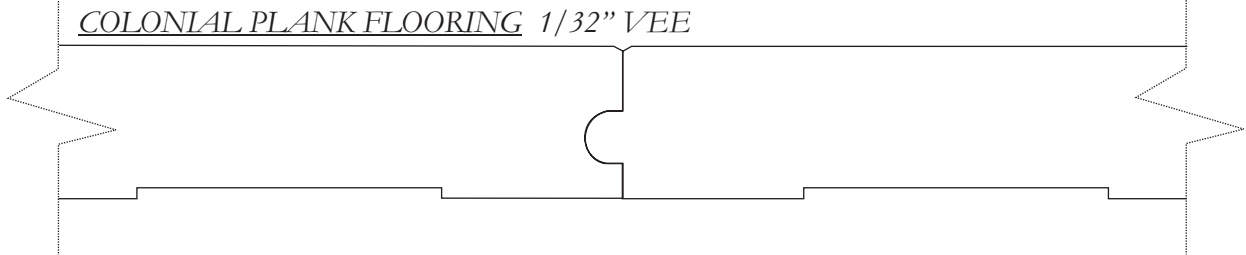

Random Width (Actual Face Widths 2 1/4" - 3 1/4" - 4 1/4" - 5 1/4" - 6 1/4" - 7 1/4")  
 Random Length (Maximum Length 16')  
 NON END MATCHED



Ⓢ STOCKED OAK, POPLAR ONLY \*STOCKED OAK, POPLAR AND PINE

# INDEX

*BEADED WAINS.	PG.54	<u>*BLC 258</u>	PG.25	*BLC 655	PG.26	NY 123	PG.20
*B-2	PG.16	*BLC 301	PG.36	*BLC 656	PG.26	NY 124	PG.20
*BLC 400	PG.19	*BLC 302	PG.36	*BLC 657	PG.30	NY 125	PG.20
BLC 001	PG.17	BLC 303	PG.37	*BLC 702	PG.43	NY 126	PG.20
*BLC 002	PG.18	*BLC 304	PG.39	*BLC 703	PG.43	NY 127	PG.20
*BLC 003	PG.19	*BLC 351	PG.37	BLC 704	PG.43	NY 128	PG.20
*BLC 004	PG.16,42	*BLC 352	PG.37	*BLC 705	PG.43	*P2	PG.46
BLC 005	PG.16	*BLC 353	PG.37,42	*BLC 750	PG.19	*P3	PG.46
*BLC 006	PG.16	*BLC 354	PG.37	*BLC 892	PG.35	*P5	PG.46
BLC 008	PG.16	*BLC 355	PG.36	<u>*BLC 893</u>	PG.35	*P6	PG.46
*BLC 010	PG.19	*BLC 356	PG.39	*BLC 904	PG.32	*ROSETTES	PG.47
*BLC 011	PG.18	*BLC 357	PG.39	<u>*BLC 954</u>	PG.32	*S4S	PG.53
BLC 053	PG.20	BLC 358	PG.36,54	*BLC 1004	PG.44	*SQUARE	PG.53
BLC 054	PG.20	BLC 360	PG.40	BLC 1103	PG.19	*T-ASTRAGAL	PG.43
BLC 055	PG.20	BLC 361	PG.39	BLC 1111	PG. 8	*WM 206	PG.44
BLC 056	PG.20	BLC 362	PG.39	BLC A-1	PG.45	<u>*WP 180</u>	PG.43
BLC 060	PG.20	*BLC 370	PG.40	*BLC A-2	PG.45	WP 320	PG.10
*BLC 061	PG.21	*BLC 370D	PG.41	*BLC A-3	PG.45	WP 330	PG.10
*BLC 102	PG. 7	BLC 451	PG.50	*C-12	PG. 7	WP 335	PG.10
*BLC 103	PG.10	BLC 455	PG.50	C-13	PG. 8	WP 340	PG.10
*BLC 104	PG.10	BLC 457	PG.50	*BLC CA-300	PG.11	WP 345	PG.10
*BLC 105	PG.10	BLC 458	PG.50	*BLC CA-301	PG.11	WP 355	PG.10
BLC 107	PG. 8	BLC 459	PG.50	*BLC CA-360	PG.11	*WP 614	PG.19
*BLC 108	PG. 8	BLC 460	PG.50	*BLC CR-2	PG.23	*WP 365	PG.10
BLC 109	PG. 8	*BLC 461	PG.52	*BLC CR-3	PG.23	WP 370	PG.10
BLC 111	PG. 7	BLC 462	PG.52	*BLC 830	PG.40	WP 375	PG.10
BLC 112	PG. 9	*BLC 501	PG.52	*BLC 860	PG.40	WP 380	PG. 9
*BLC 113	PG. 8	*BLC 601	PG.28	*BLC 862	PG.41	WP 385	PG. 9
BLC 114	PG. 7	*BLC 602	PG.27	*D-1	PG.42	*1505	PG.28
BLC 125	PG. 8	BLC 603	PG.27	DC-12	PG.14	8000	PG.38
BLC 126	PG. 8	BLC 604	PG.28	DC 67	PG.14	8001	PG.40
BLC 127	PG. 8	*BLC 605	PG.28	DC 81	PG.14	8002	PG.38
BLC 129	PG. 8	BLC 606	PG.27	DC 100	PG.14	8003	PG.38
BLC 130	PG. 7	BLC 607	PG.28	*DOWEL 1.5	PG.52	8004	PG.38
BLC 131	PG. 7	*BLC 608	PG.28	EXP 361	PG. 7	8005	PG.38
BLC 133	PG. 8	*BLC 609	PG.27	<u>*EXP 361</u>	PG. 8	8006	PG.38
*BLC 135	PG.11	BLC 610	PG.28	M-166	PG.30	8007	PG.38
*BLC 136	PG.11	*BLC 611	PG.28	*MOULD A	PG.27	8008	PG.38
BLC 140	PG. 8	*BLC 613	PG.27	NY 100	PG.14	8011	PG.37
BLC 141	PG. 8	*BLC 614	PG.27	NY 102	PG.26	8012	PG.37
*BLC 200	PG.22	*BLC 615	PG.28	NY 103	PG.26	8014	PG.37
BLC 201	PG.27	BLC 616	PG.28	NY 104	PG.26	8015	PG.36
BLC 203	PG.22	*BLC 617	PG.28	NY 108	PG.37	8017	PG.36
*BLC 204	PG.22	BLC 618	PG.28	NY 109	PG.30	8018	PG.36
BLC 205	PG.22	*BLC 620	PG.27	NY 110	PG.15	8020	PG.36
BLC 207	PG.22	*BLC 621	PG.27	NY 111	PG.15	8021	PG.36
*BLC 208	PG.22	*BLC 622	PG.27	NY 112	PG.15	8022	PG.38
BLC 210	PG.22,25	*BLC 625	PG.28	NY 114	PG.19	8023	PG.36
BLC 211	PG.25	BLC 626	PG.27	NY 115	PG.34	8025	PG.36
BLC 220	PG.22	*BLC 628	PG.28	NY 116	PG.20	*8029	PG.36
BLC 252	PG.25	BLC 630	PG.27	NY 117	PG.20	8030	PG.35
BLC 254	PG.25	*BLC 640	PG.28	NY 118	PG.20	8031	PG.35
*BLC 255	PG.25	BLC 651	PG.26	NY 119	PG.20	8032	PG.35
BLC 256	PG.25	*BLC 652	PG.26	NY 120	PG.20	8033	PG.35
BLC 257	PG.25	BLC 653	PG.26	NY 121	PG.20	8051	PG.36
		BLC 654	PG.26	NY 122	PG.20	8054	PG.35

\*STOCKED OAK, POPLAR ONLY \* STOCKED OAK, POPLAR AND PINE



## INDEX

8055	PG.36	8191	PG.33	8447	PG.21	8581	PG.31
8056	PG.36	8192	PG.33	8448	PG.21	8583	PG.31
8057	PG.32	8193	PG.33	8449	PG.21	8584	PG.31
8058	PG.32	8194	PG.33	8454	PG.29	8586	PG.31
8059	PG.35	8195	PG.33	8486	PG.30	8587	PG.31
8060	PG.35	*8201	PG.44	8487	PG.30	8588	PG.31
8061	PG.35	8202	PG.44	8488	PG.30	8589	PG.31
*8062	PG.35	8203	PG.44	8490	PG.30	8590	PG.31
*8063	PG.32	8204	PG.44	8492	PG.29	8600	PG.30
8064	PG.32	8205	PG.44	8493	PG.29	8601	PG.30
8066	PG.32	8221	PG.30	8494	PG.29	*8610	PG.31
8067	PG.32	8222	PG.24	8495	PG.29	*8611	PG.31
8068	PG.32	8238	PG.44	8496	PG.29	*8619	PG.30
8069	PG.32	8242	PG.44	8497	PG.23	*8620	PG.30
*8070	PG.32	8271	PG.24	8498	PG.29	*8621	PG.30
8071	PG.32	8273	PG.24	8499	PG.29	8623	PG.37
8072	PG.32	8275	PG.33	8500	PG.35	8624	PG.37
8073	PG.32	8276	PG.33	8501	PG.35	*8625	PG.37
8074	PG.32	8277	PG.24	8502	PG.35	8635	PG.13
8075	PG.32	8278	PG.44	8503	PG.35	8636	PG.13
8076	PG.32	8279	PG.33	*8504	PG.35	8640	PG. 9
*8078	PG.32	8280	PG.33	8505	PG.35	8644	PG.14
8079	PG.32	8281	PG.33	8506	PG.35	8706	PG. 9
8080	PG.32	8289	PG. 9	8507	PG.35	8709	PG.17
8081	PG.32	8296	PG.30	8520	PG.36	8711	PG.13
8095	PG.43	8297	PG.30	*8530	PG.35	8712	PG.13
8123	PG.34	8313	PG.15	8531	PG.35	8713	PG.15
8124	PG.34	*8314	PG.15	8532	PG.35	8716	PG.18
8125	PG.34	8315	PG.15	8535	PG.35	8728	PG.18
8126	PG.31	8317	PG.15	8536	PG.23	8741	PG.17
8127	PG.31	8341	PG. 9	8537	PG.23	8742	PG.12
8128	PG.31	8358	PG.13	8538	PG.23	8743	PG.12
*8130	PG.34	8368	PG.15	8539	PG.23	8747	PG.12
8131	PG.34	8374	PG.15	8540	PG.31	8748	PG.12
8132	PG.34	8378	PG.15	8560	PG.31	8749	PG.12
8133	PG.34	8379	PG.15	8561	PG.31	8750	PG.12
8134	PG.31	8387	PG.15	8562	PG.31	8752	PG.12
8136	PG.31	8405	PG.21	8563	PG.31	8754	PG.12
8137	PG.31	8406	PG.21	8564	PG.31	8755	PG.13
8138	PG.31	8407	PG.21	8565	PG.31	8829	PG.49
*8139	PG.31	8408	PG.21	8566	PG.31	8830	PG.49
8140	PG.31	8409	PG.21	8567	PG.31	8831	PG.49
8141	PG.31	8411	PG.21	8568	PG.31	8832	PG.49
8142	PG.31	8412	PG.21	8569	PG.31	8833	PG.49
8143	PG.34	8414	PG.21	*8570A	PG.25,31	8834	PG.51
8144	PG.34	8415	PG.18	*8570B	PG.31	8835	PG.51
8147	PG.34	8416	PG.21	*8570C	PG.31	8836	PG.51
8148	PG.43	8417	PG.21	8572	PG.34	8839	PG.51
8161	PG.30	8418	PG.21	8573	PG.34	*8842	PG.22
8174	PG.30	8419	PG.21	8574	PG.34	8843	PG.14
8177	PG.30	8420	PG.21	*8575	PG.34	8845	PG.14
8186	PG.24	8421	PG.17	8576	PG.34	8848	PG.51
8187	PG.24	8423	PG.19	8577	PG.34	8917	PG.44
8188	PG.24	8425	PG.19	8578	PG.34	8918	PG.44
8189	PG.24	8426	PG.17	8579	PG.31	8919	PG.44
8190	PG.33	8442	PG.23	8580	PG.31	8920	PG.44

\*STOCKED OAK, POPLAR ONLY \*STOCKED OAK, POPLAR AND PINE



*SHORT TREE PRODUCTS offer  
a complete line of mouldings. From  
RESIDENTIAL, COMMERCIAL  
to ARCHITECTURAL woodwork.  
Available through your local dealer.*



*LOOK FOR SHORT TREE SIGN  
THE SIGN OF QUALITY*

*Visit us on the Web  
[www.shorttreeproducts.com](http://www.shorttreeproducts.com)*